



November 4, 2015

---

# 5G Waveform & Multiple Access Techniques

---

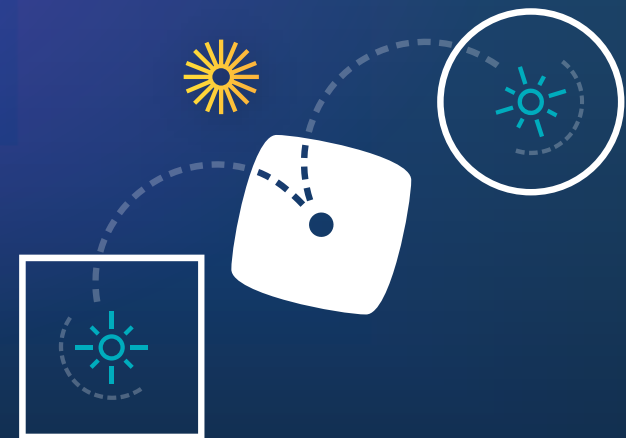

# Outline

## Executive summary

## Waveform & multi-access techniques evaluations and recommendations

- Key waveform and multiple-access design targets
- Physical layer waveforms comparison
- Multiple access techniques comparison
- Recommendations

## Additional information on physical layer waveforms

- Single carrier waveform
- Multi-carrier OFDM-based waveform

## Additional information on multiple access techniques

- Orthogonal and non-orthogonal multiple access

## Appendix

- References
- List of abbreviations

# Executive summary



# Executive Summary

- 5G will support diverse use cases
  - Enhanced mobile broadband, wide area IoT, and high-reliability services
- OFDM family is well suited for mobile broadband and beyond
  - Efficient MIMO spatial multiplexing for higher spectral efficiency
  - Scalable to wide bandwidth with lower complexity receivers
- CP-OFDM/OFDMA for 5G downlink
  - CP-OFDM with windowing/filtering delivers higher spectral efficiency with comparable out-of-band emission performance and lower complexity than alternative multi-carrier waveforms under realistic implementations
  - Co-exist with other waveform & multiple access options for additional use cases and deployment scenarios
- SC-FDM/SC-FDMA for scenarios requiring high energy efficiency (e.g. macro uplink)
- Resource Spread Multiple Access (RSMA) for use cases requiring asynchronous and grant-less access (e.g. IoT)

# OFDM-based waveform & multiple access are recommended for 5G

Additional waveform & multiple access options are included to support specific scenarios

Downlink recommendation  
(for all use cases):

- Waveform: OFDM<sup>1</sup>
- Multiple access: OFDMA

## eMBB for Sub-6GHz

- Licensed macro uplink
  - Waveform: OFDM, SC-FDM
  - Multiple access: OFDMA, SC-FDMA, RSMA
- Unlicensed and small cell uplink
  - Waveform: OFDM
  - Multiple access: OFDMA

## Wide Area IoT

- Uplink:
  - Waveform: SC-FDE
  - Multiple access: RSMA

## mmWave

- Uplink:
  - Waveform: OFDM, SC-FDM
  - Multiple access: OFDMA, SC-FDMA

## High-Reliability Services<sup>2</sup>

- Uplink
  - Waveform: OFDM, SC-FDM
  - Multiple access: OFDMA, SC-FDMA, RSMA

1. OFDM waveform in this slide refers to OFDM with cyclic prefix and windowing. 2. with scaled frame numerology to meet tighter timeline for high-reliability services

# Waveform & multiple access techniques evaluation and recommendations



# 5G design across services

Enhanced Mobile Broadband (eMBB) is the anchor technology on to which other 5G services are derived

## Motivations of waveform & multi-access design

- Support wide range of use cases:
  - eMBB: higher throughput / higher spectral efficiency
  - Wide area IoT: massive number of low-power small-data-burst devices with limited link budget
  - Higher-reliability: services with extremely lower latency and higher reliability requirements
- Accommodate different numerologies optimized for specific deployment scenarios and use cases
- Minimize signaling and control overhead to improve efficiency

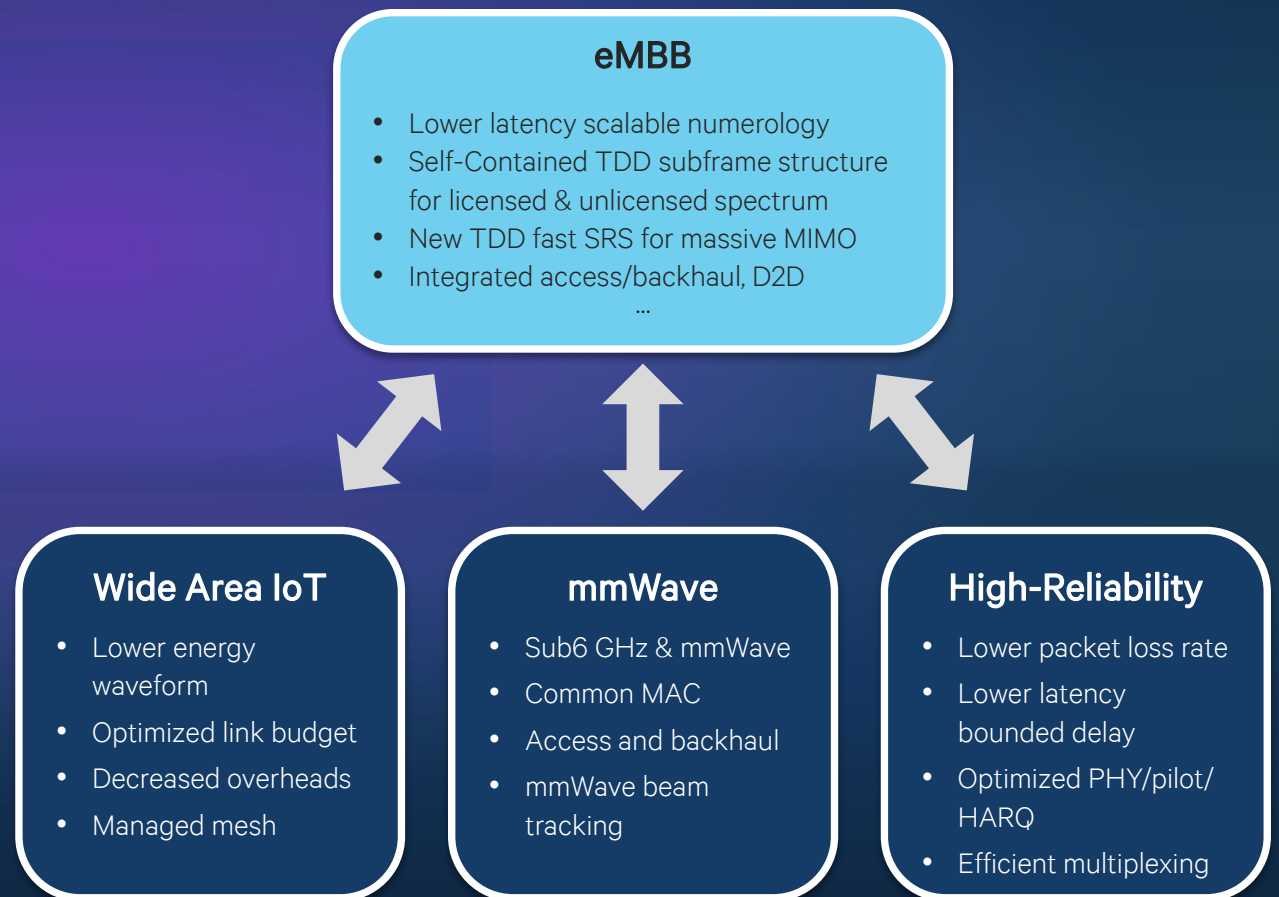



# Key design targets for physical layer waveform

Key design targets	Additional details
Higher spectral efficiency	<ul style="list-style-type: none"><li>• Ability to efficiently support MIMO</li><li>• Multipath robustness</li></ul>
Lower in-band and out-of-band emissions	<ul style="list-style-type: none"><li>• Reduce interference among users within allocated band</li><li>• Reduce interference among neighbor operators, e.g. achieve low ACLR</li></ul>
Enables asynchronous multiple access	<ul style="list-style-type: none"><li>• Support a higher number of small cell data burst devices with minimal scheduling overhead through asynchronous operations</li><li>• Enables lower power operation</li></ul>
Lower power consumption	<ul style="list-style-type: none"><li>• Requires low PA backoff leading to high PA efficiency</li></ul>
Lower implementation complexity	<ul style="list-style-type: none"><li>• Reasonable transmitter and receiver complexity</li><li>• Additional complexity must be justified by significant performance improvements</li></ul>



# Key design targets for multiple access technique

Key design targets	Additional details
Higher network spectral efficiency	<ul style="list-style-type: none"><li>• Maximize spectral efficiency across users and base stations</li><li>• Enable MU-MIMO</li></ul>
Link budget and capacity trade off	<ul style="list-style-type: none"><li>• Maximize link budget and capacity taking into consideration their trade off as well as the target use case requirements</li></ul>
Lower overhead	<ul style="list-style-type: none"><li>• Minimize protocol overhead to improve scalability, reduce power consumption, and increase capacity</li><li>• Lower control overhead</li></ul>

# Quick refresh on OFDM

## Orthogonal Frequency Division Multiplexing

Simplified OFDM waveform synthesis for a transmitter

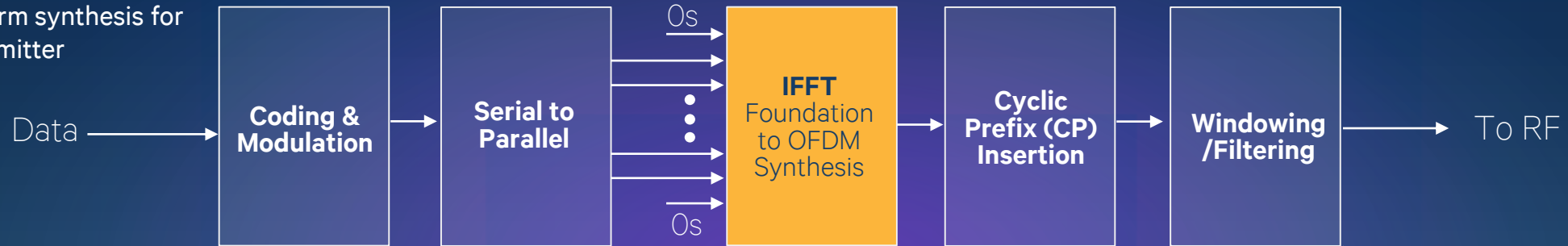

Data transmitted via closely-spaced, narrowband subcarriers – IFFT operation ensures subcarriers do not interfere with each other

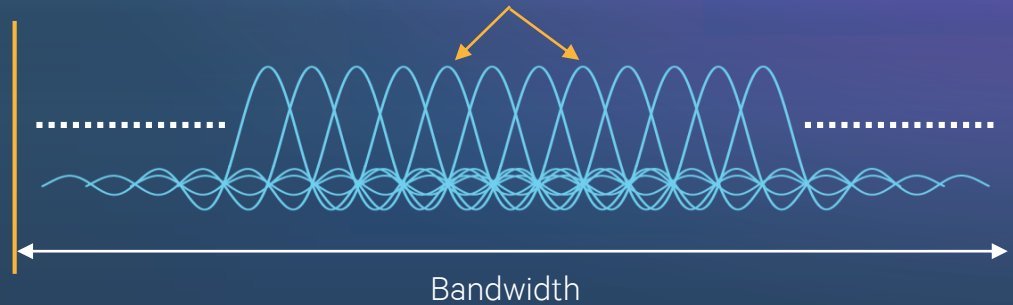

Helps maintain orthogonality despite multipath fading

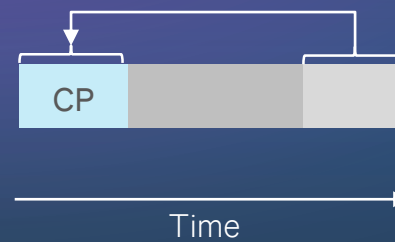

Windowing reduces out-of-band emissions

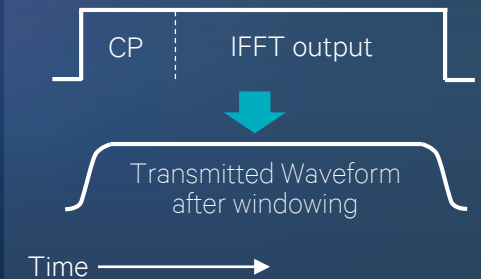

OFDM-based waveforms are the foundations for LTE and Wi-Fi systems today

# OFDM family well suited to meet the evolving requirements

Additional waveform & multiple access options can complement OFDM to enable more use cases

## Higher spectral efficiency



Efficiently support MIMO spatial multiplexing with wide bandwidths and larger array sizes

## Lower out-of-band emissions

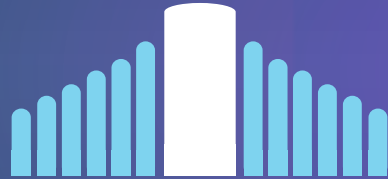

Windowing effectively enhances frequency localization

## Asynchronous multiplexing

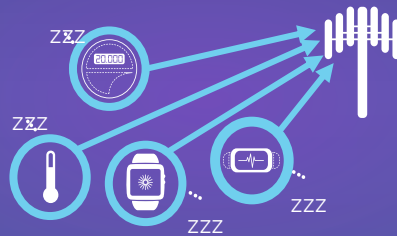

Can co-exist with other waveform/multi-access within the same framework to support wide area IoT

## Lower complexity



Lower complexity receivers even when scaling to wide bandwidths with frequency selectivity

## Lower power consumption

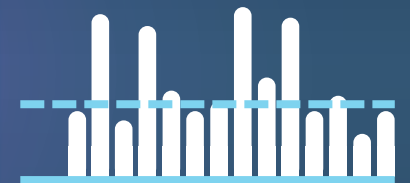

Single-carrier OFDM waveform for scenarios with higher power efficiency requirements

# Numerous OFDM-based waveforms considered

Different implementation options and optimizations

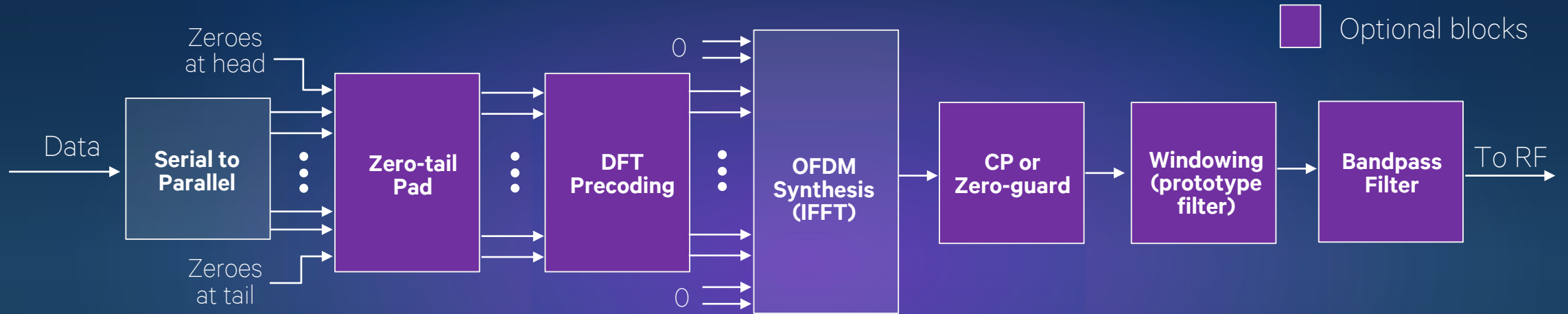

Waveforms	A	B	IFFT	C	D	E
CP-OFDM + WOLA <sup>1</sup>			✓	CP	✓	} LTE DL } LTE UL
SC-FDM + WOLA		✓	✓	CP	✓	
UFMC			✓	ZG		✓
FBMC			✓		✓	
Zero-tail SC-FDM	✓	✓	✓			

<sup>1</sup> Weighted OverLap and Add (WOLA) – Windowing technique popular in 4G LTE systems today  
© 2015 Qualcomm Technologies, Inc. All rights reserved.

# Summary of single-carrier waveforms

Waveforms	Pros	Cons
<b>Constant envelope</b> (e.g., GMSK in GSM and Bluetooth LE; MSK in Zigbee)	<ul style="list-style-type: none"> <li>• 0dB PAPR</li> <li>• Allow asynchronous multiplexing</li> <li>• Good side lobe suppression (GMSK)</li> </ul>	<ul style="list-style-type: none"> <li>• Lower spectral efficiency</li> </ul>
<b>SC-QAM</b> (in EV-DO, UMTS)	<ul style="list-style-type: none"> <li>• Low PAPR at low spectral efficiency</li> <li>• Allow asynchronous multiplexing</li> <li>• Simple waveform synthesis</li> </ul>	<ul style="list-style-type: none"> <li>• Limited flexibility in spectral assignment</li> <li>• Non-trivial support for MIMO</li> </ul>
<b>SC-FDE</b>	<ul style="list-style-type: none"> <li>• Equivalent to SC-QAM with CP</li> <li>• Allow FDE processing</li> </ul>	<ul style="list-style-type: none"> <li>• Similar as SC-QAM</li> <li>• ACLR similar to DFT-spread OFDM</li> </ul>
<b>SC-FDM<sup>1</sup></b> (in LTE uplink)	<ul style="list-style-type: none"> <li>• Flexible bandwidth assignment</li> <li>• Allow FDE processing</li> </ul>	<ul style="list-style-type: none"> <li>• Higher PAPR and worse ACLR than SC-QAM</li> <li>• Need synchronous multiplexing</li> </ul>
<b>Zero-tail SC-FDM<sup>2</sup></b>	<ul style="list-style-type: none"> <li>• Flexible bandwidth assignment</li> <li>• No CP, but flexible inter-symbol guard</li> <li>• Better OOB suppression than SC-FDM without WOLA</li> </ul>	<ul style="list-style-type: none"> <li>• Need synchronous multiplexing</li> <li>• Need extra control signaling</li> <li>• Lack of CP makes multiplexing with CP-OFDM less flexible</li> </ul>

1. Also referred to as SC DFT-spread OFDM. 2. Also referred to as Zero-tail SC DFT-spread OFDM

# Summary of OFDM-based multi-carrier waveforms

Waveforms	Pros	Cons
<b>CP-OFDM</b> (in LTE spec. but existing implementations typically include WOLA to meet performance requirements)	<ul style="list-style-type: none"> <li>• Flexible frequency assignment</li> <li>• Easy integration with MIMO</li> </ul>	<ul style="list-style-type: none"> <li>• High ACLR – side lobe decays slowly</li> <li>• Need synchronous multiplexing</li> </ul>
<b>CP-OFDM with WOLA</b> (in existing LTE implementations)	<ul style="list-style-type: none"> <li>• All pros from CP-OFDM</li> <li>• Better OOB suppression than CP-OFDM</li> <li>• Simple WOLA processing</li> </ul>	
<b>UFMC</b>	<ul style="list-style-type: none"> <li>• Better OOB leakage suppression than CP-OFDM (but not better than CP-OFDM with WOLA)</li> </ul>	<ul style="list-style-type: none"> <li>• ISI from multipath fading (no CP)</li> <li>• Higher Tx complexity than CP-OFDM</li> <li>• Higher Rx complexity (2x FFT size) than CP-OFDM</li> </ul>
<b>FBMC</b>	<ul style="list-style-type: none"> <li>• Better than CP-OFDM with WOLA (but the improvement is reduced with PA nonlinearity)</li> </ul>	<ul style="list-style-type: none"> <li>• High Tx/Rx complexity due to OQAM (waveform is synthesized per RB)</li> <li>• Integration with MIMO is nontrivial</li> <li>• Subject to ISI under non-flat channels</li> </ul>
<b>GFDM</b>	<ul style="list-style-type: none"> <li>• Same leakage suppression as CP-OFDM with WOLA</li> </ul>	<ul style="list-style-type: none"> <li>• Complicated receiver to handle ISI/ICI</li> <li>• Higher block processing latency (no pipelining)</li> <li>• Multiplex with eMBB requires large guard band</li> </ul>



# Summary of multiple access techniques

Multiple access	Pros	Cons
<b>SC-FDMA</b> (in LTE uplink)	<ul style="list-style-type: none"> <li>• With PAPR/coverage</li> <li>• Multiplexing with OFDMA</li> </ul>	<ul style="list-style-type: none"> <li>• Need synchronous multiplexing</li> <li>• Link budget loss for large number of simultaneous users</li> </ul>
<b>OFDMA</b> (in LTE downlink)	<ul style="list-style-type: none"> <li>• No intra-cell interference</li> <li>• higher spectral efficiency and MIMO</li> </ul>	<ul style="list-style-type: none"> <li>• Need synchronous multiplexing</li> <li>• Link budget loss for large number of simultaneous users</li> </ul>
<b>Single-carrier RSMA</b>	<ul style="list-style-type: none"> <li>• Allow asynchronous multiplexing</li> <li>• Grantless Tx with minimal signaling overhead</li> <li>• Link budget gain</li> </ul>	<ul style="list-style-type: none"> <li>• Not suitable for higher spectral efficiency</li> </ul>
<b>OFDM-based RSMA</b>	<ul style="list-style-type: none"> <li>• Grantless Tx with minimal signaling overhead</li> </ul>	<ul style="list-style-type: none"> <li>• Need synchronous multiplexing</li> </ul>
<b>LDS-CDMA/SCMA</b>	<ul style="list-style-type: none"> <li>• Allow lower complexity iterative message passing multiuser detection (when there are small number of users)</li> </ul>	<ul style="list-style-type: none"> <li>• Higher PAPR than SC RSMA</li> <li>• Need synchronous multiplexing</li> <li>• Lack of scalability/flexibility to users requiring different spreading factors</li> <li>• Not exploiting full diversity</li> </ul>
<b>MUSA</b>	<ul style="list-style-type: none"> <li>• Similar to LDS-CDMA with SIC</li> </ul>	<ul style="list-style-type: none"> <li>• Higher PAPR</li> </ul>



# Waveform comparison

Waveforms	SC-QAM	SC-FDM/ SC-FDE	Zero-tail SC-FDM	CP-OFDM with WOLA	UFMC	FBMC	GFDM
Higher spectral efficiency with efficient MIMO integration				✓	✓		
Lower in-band and OOB emissions	✓	✓	✓	✓	✓	✓	✓
Enables asyn. multiple access	✓	✓					
Lower power consumption	✓	✓	✓				
Lower implementation complexity	✓	✓	✓	✓			

- CP-OFDM with WOLA offers higher spectral efficiency and low implementation complexity, and is suitable for the downlink where energy efficiency requirement is more relaxed
- Other waveform and multiple access options can co-exist with CP-OFDM within the same framework to support additional scenarios:
  - SC-FDM with orthogonal multiple access on macro uplink for better PA efficiency
  - SC-FDM with RSMA for use cases requiring grant-less asynchronous access

# Summary of recommendations

Use cases		Key requirements	Recommended waveform / multiple access
eMBB	Uplink	<ul style="list-style-type: none"> <li>Macro cell: low PAPR as devices are power-limited</li> </ul>	<ul style="list-style-type: none"> <li>Macro cell: SC-FDM / SC-FDMA</li> </ul>
		<ul style="list-style-type: none"> <li>Small cell/unlicensed: higher spectral efficiency due to transmit power limitation</li> </ul>	<ul style="list-style-type: none"> <li>Small cell/unlicensed: CP-OFDM with WOLA / OFDMA</li> </ul>
	Downlink	<ul style="list-style-type: none"> <li>Higher peak spectral efficiency</li> <li>Fully leverage spatial multiplexing</li> </ul>	<ul style="list-style-type: none"> <li>CP-OFDM with WOLA / OFDMA</li> </ul>
Wide area IoT	Uplink	<ul style="list-style-type: none"> <li>Support short data bursts</li> <li>Long device battery life</li> <li>Deep coverage</li> </ul>	<ul style="list-style-type: none"> <li>SC-FDE / RSMA</li> </ul>
	Downlink		<ul style="list-style-type: none"> <li>CP-OFDM with WOLA / OFDMA<sup>1</sup></li> </ul>
Higher-reliability services	Uplink	<ul style="list-style-type: none"> <li>Lower latency</li> <li>Lower packet loss rate</li> </ul>	<ul style="list-style-type: none"> <li>Macro cell: SC-FDM / SC-FDMA or RSMA<sup>2</sup></li> <li>Small cell and unlicensed: CP-OFDM with WOLA / OFDMA<sup>2</sup></li> </ul>
	Downlink		<ul style="list-style-type: none"> <li>CP-OFDM with WOLA / OFDMA<sup>1,2</sup></li> </ul>

1. For IoT and high-reliability downlink, PAPR is not the most critical constraint, and synchronization among user is not a concern. Therefore it is desirable to use the same waveform and multi-access as nominal traffic

2. The numerology for subframe and HARQ timeline may need to be condensed to provide very high reliability in a shorter time span.

# Additional information on physical layer waveforms



# Potential waveform options

## Single-carrier waveform

- Time domain symbol sequencing:
  - Typically lower PAPR leading to high PA efficiency and extended battery life
  - Equalizer is needed to achieve high spectral efficiency in the presence of multipath
- Example waveforms:
  - Constant envelopes waveform, such as:
    - MSK (adopted by IEEE 802.15.4)
    - GMSK (adopted by GSM and Bluetooth)
  - SC-QAM (adopted by EV-DO and UMTS)
  - SC-FDE (adopted by IEEE 802.11ad)
  - SC-FDM (adopted by LTE uplink)
  - Zero-tail SC-FDM

## OFDM-based multi-carrier waveform

- Frequency domain symbol sequencing
  - Support multiple orthogonal sub-carriers within a given carrier bandwidth
  - Typically easy integration with MIMO leading to improved spectral efficiency
- Example waveforms:
  - CP-OFDM (adopted by LTE spec)
  - CP-OFDM w/ WOLA (existing LTE implementation)
  - UFMC
  - FBMC
  - GFDM

# Constant envelope waveforms

## MSK Transmitter

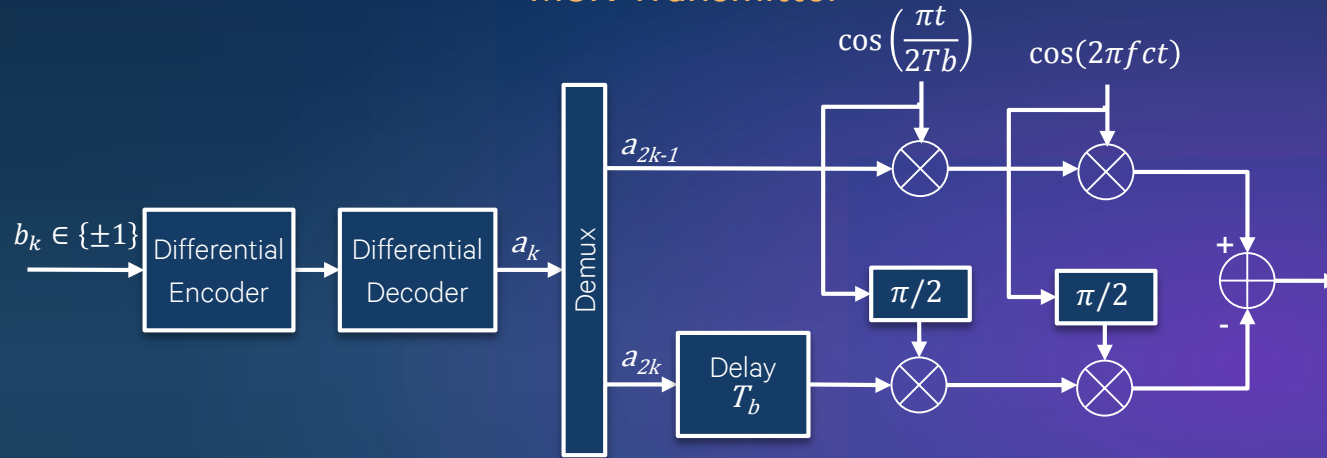

## MSK Receiver

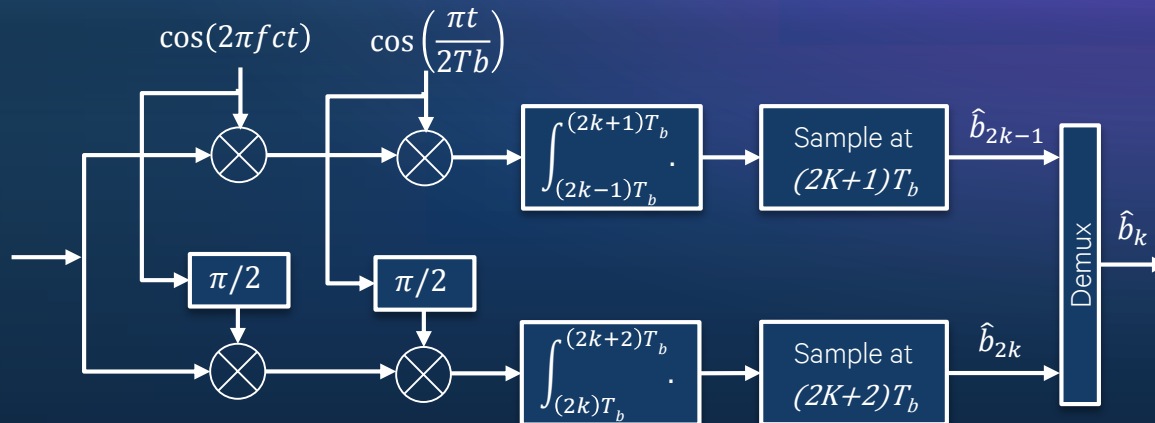

## Key characteristics

- Pros:
  - Higher transmit efficiency:
    - Constant transmit carrier power: 0dB PAPR
    - Allow PA to run at saturation point
  - Good side lobe suppression (e.g. GMSK)
  - Allow asynchronous multiplexing
  - Reasonable receiver complexity
- Cons:
  - Lower spectral efficiency
- Example applications:
  - MSK (adopted by Zigbee and IEEE 802.15.4)
  - GMSK (adopted by GSM and Bluetooth LE)

# Single carrier QAM

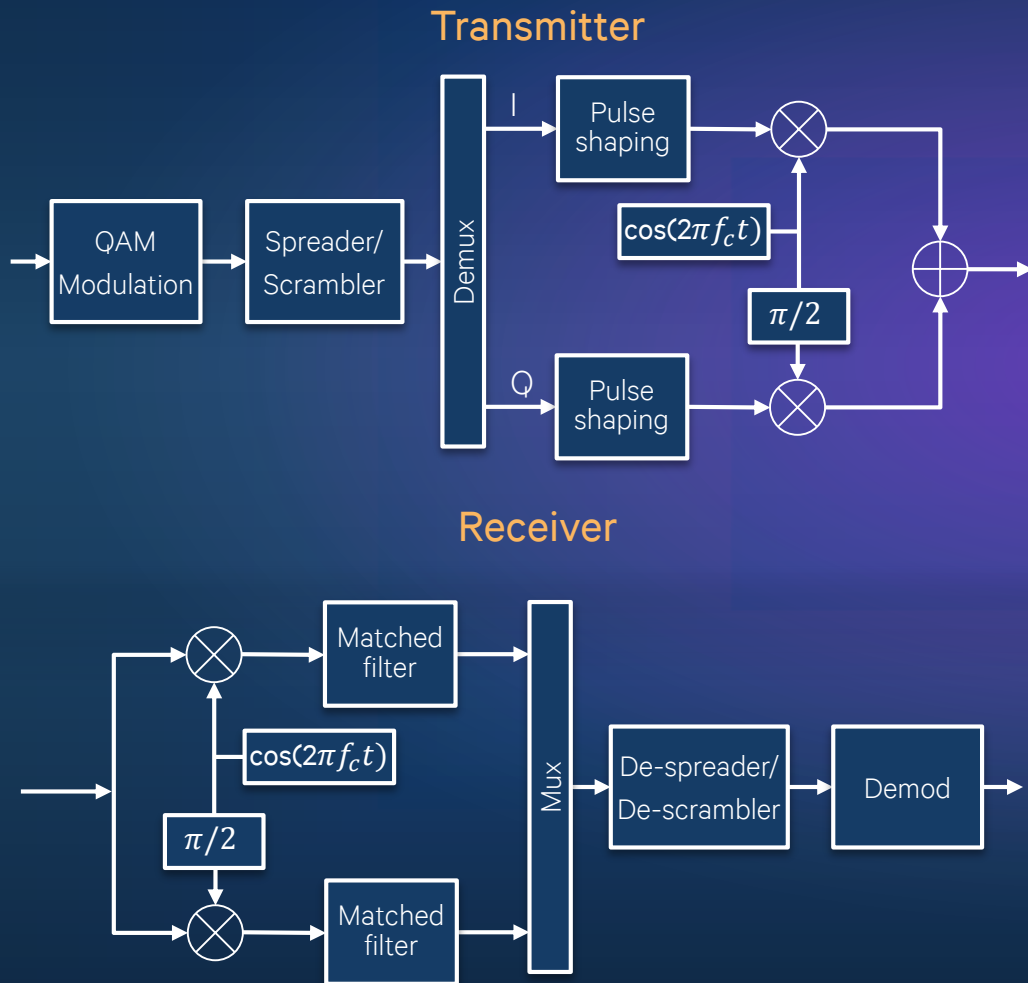

## Key characteristics

- Pros:
  - Lower PAPR at low spectral efficiency
  - Lower ACLR with the use of pulse shaping filter
  - Allow asynchronous multiplexing
  - Simple waveform synthesis
  - Higher spectral efficiency than constant envelope waveform using a single carrier
- Cons:
  - Limited flexibility in spectral assignment
  - Non-trivial support for MIMO
  - Equalization algorithm for improving spectral efficiency increases receiver complexity
- Example applications:
  - UMTS, CDMA2000, 1xEVDO

# Single carrier frequency domain equalization (SC-FDE)

## Transmitter



## Receiver

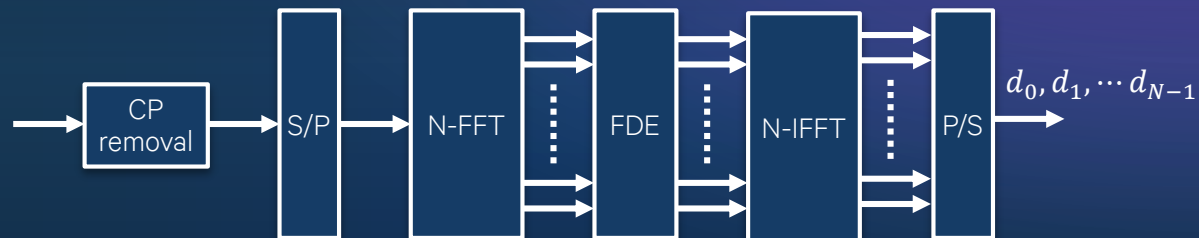

## Key characteristics

- Equivalent to SC-QAM with CP
- Pros:
  - Enable simple FDE implementation for single carrier waveform to Improve spectral efficiency under multipath fading
- Cons:
  - Slight spectral efficiency degradation due to the added Cyclic Prefix (CP)
  - Higher ACLR than SC-QAM



# Single Carrier FDM

## Transmitter

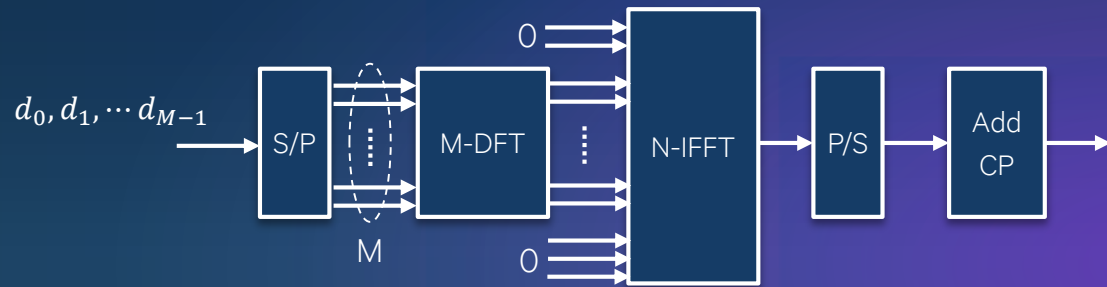

## Receiver

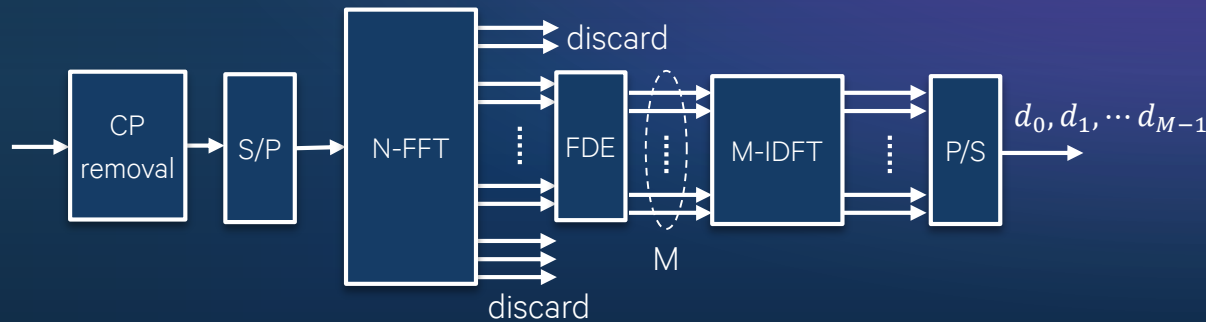

## Key characteristics

- Pros:
  - Support dynamic bandwidth allocation
  - Flexibility in allocating different bandwidth to multiple users through frequency multiplexing (referred to as SC-FDMA)
  - Mitigate multipath degradation with FDE
- Cons:
  - Higher PAPR than SC-QAM
  - Higher ACLR than SC-QAM
  - Need synchronous multiplexing
- Example applications:
  - LTE uplink

# Weighted Overlap and Add (WOLA)

Significant improvement to out-of-band and in-band asynchronous user interference suppression

## Practical implementations using time domain windowing

WOLA processing at Transmitter (Tx-WOLA)

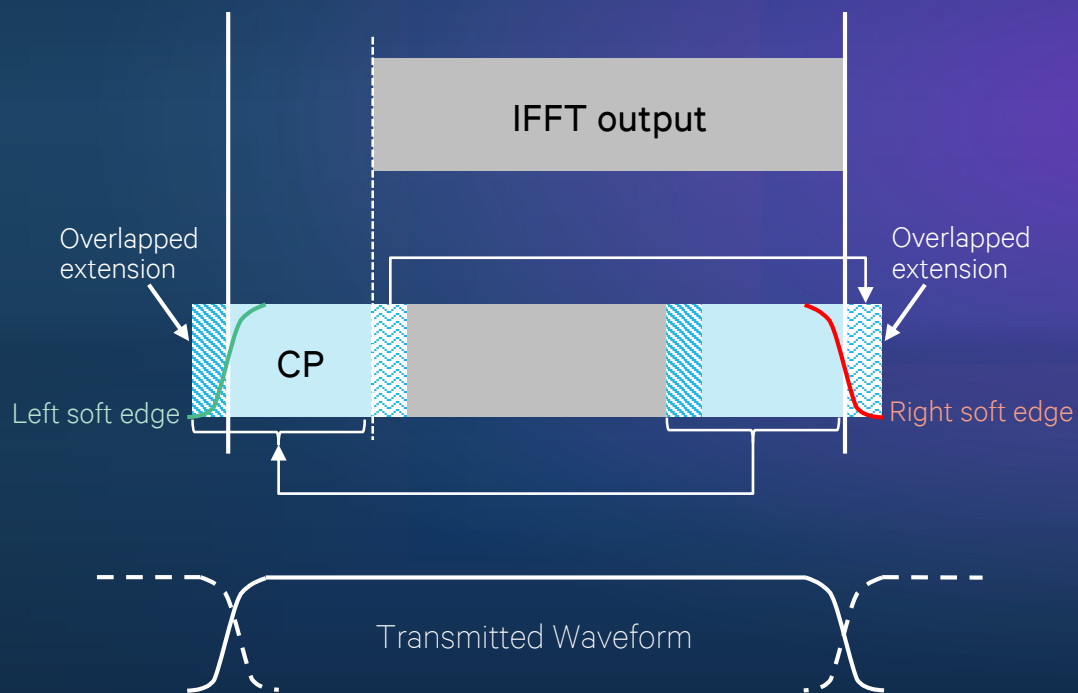

WOLA processing at Receiver (Rx-WOLA)

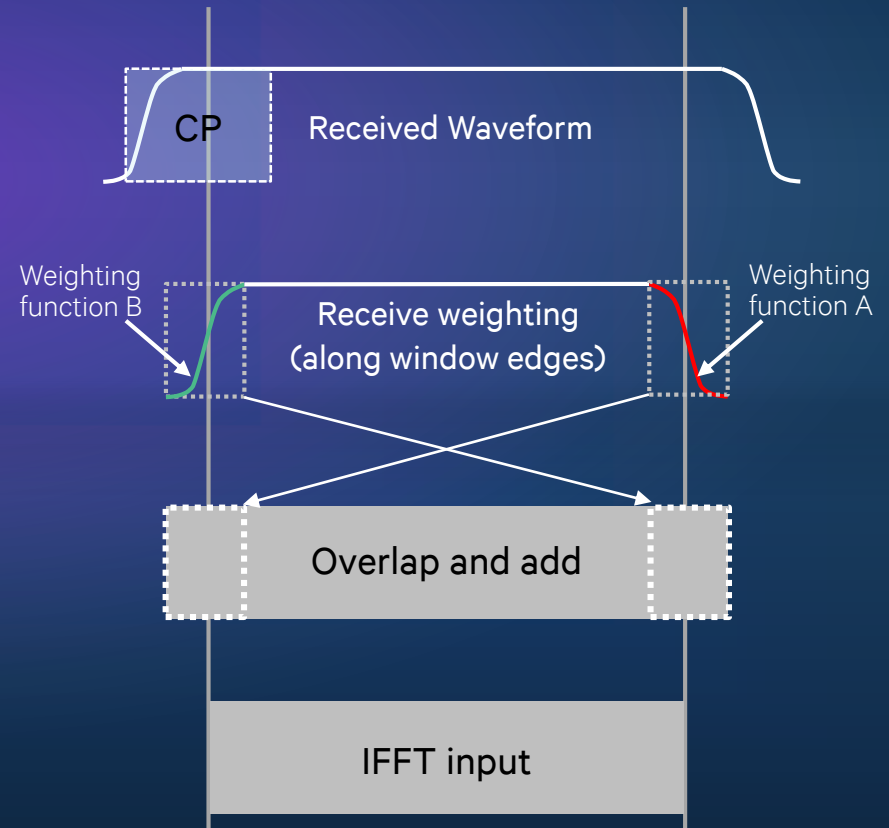

# Improved OOB performance with WOLA

## PSD of SC-FDM without WOLA

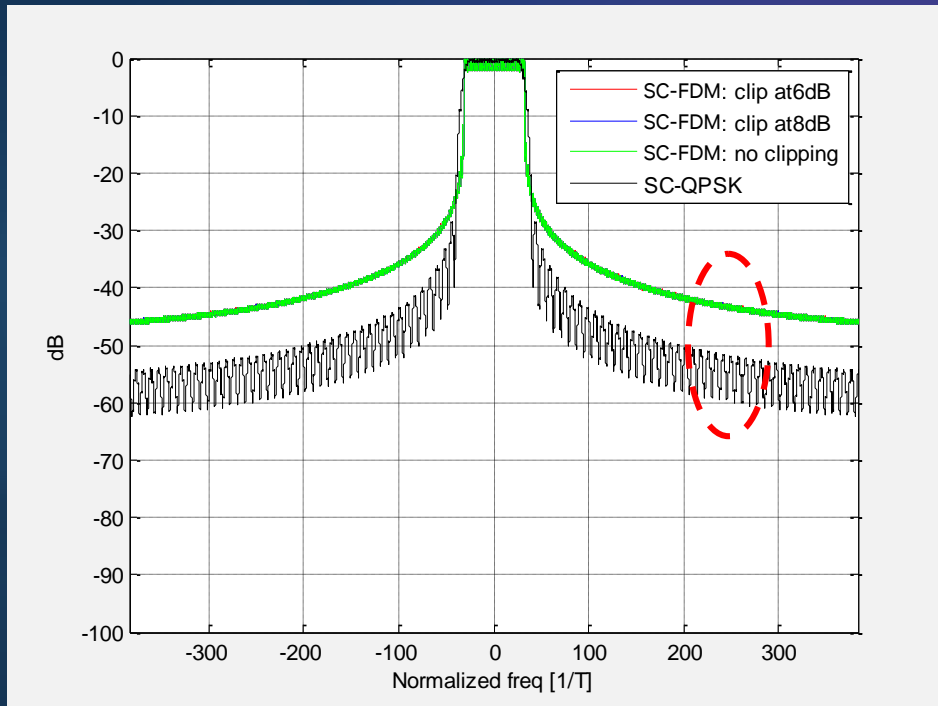

Higher OOB leakage than SC-QPSK due to discontinuities between OFDM transmission blocks

## PSD of SC-FDM with WOLA

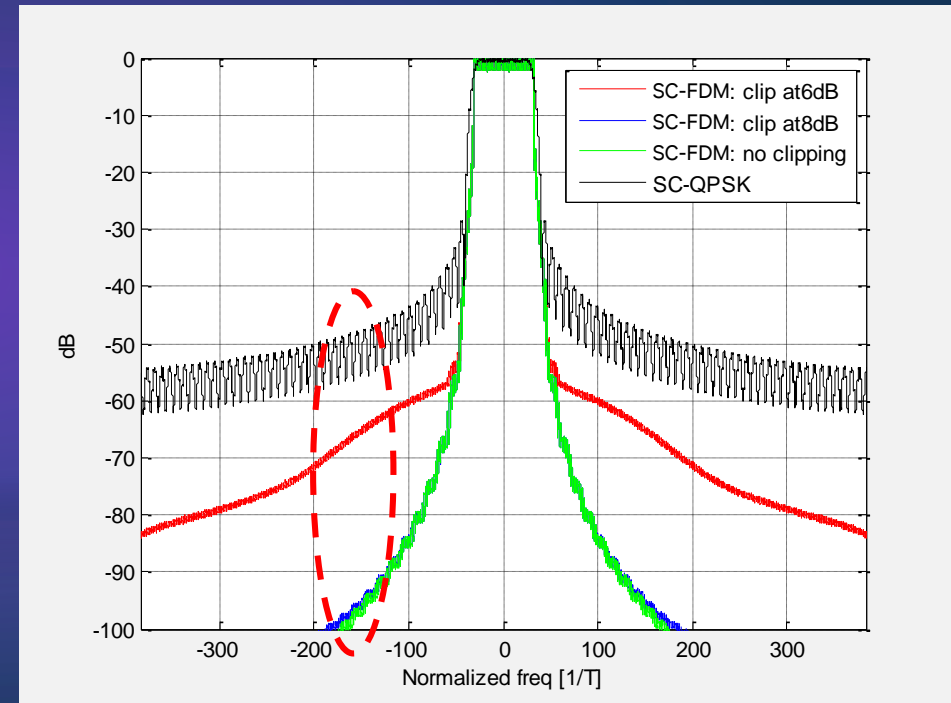

Significant improvement to OOB leakage performance using time-domain windowing (WOLA)

Assumptions: SC-FDM: 60 symbols per run, 1000 runs. CP length is set to be roughly 10% of the OFDM symbol length. For Tx-WOLA, raised-cosine edge with rolloff  $\alpha \approx 0.64$  is used.

# Zero-Tail SC-FDM

## Transmitter

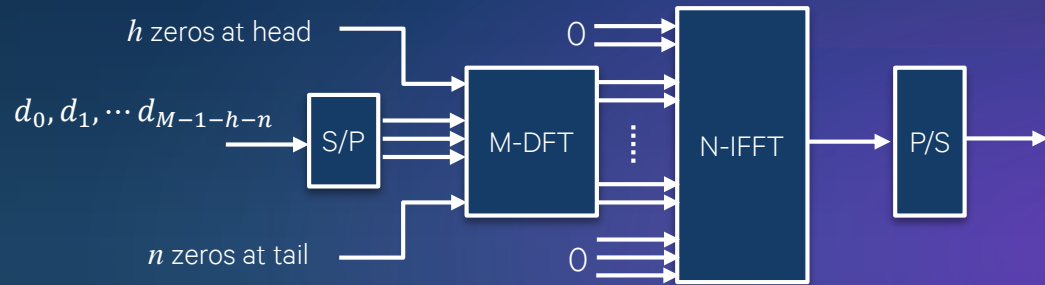

## Receiver

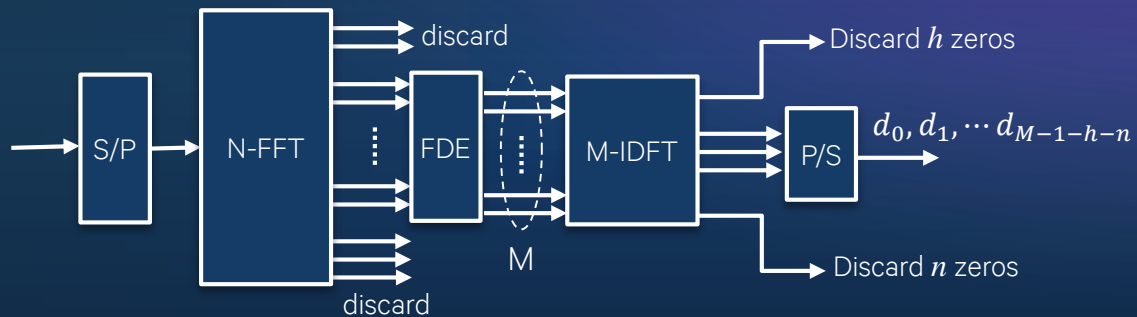

## Key characteristics

- Pros:
  - Flexible bandwidth assignment
  - No CP but support variable zero tail length, based on channel delay spread on a per-user basis
  - Improved spectral efficiency for some users – up to 7% due to removal of CP
  - Better OOB suppression than DFT-spread OFDM but worse than DFT-spread OFDM with WOLA
- Cons:
  - Need synchronous multiplexing
  - Extra signaling overhead to configure zero-tail
  - Lack of CP makes multiplexing with OFDM less flexible due to different symbol size

# CP-OFDM waveform

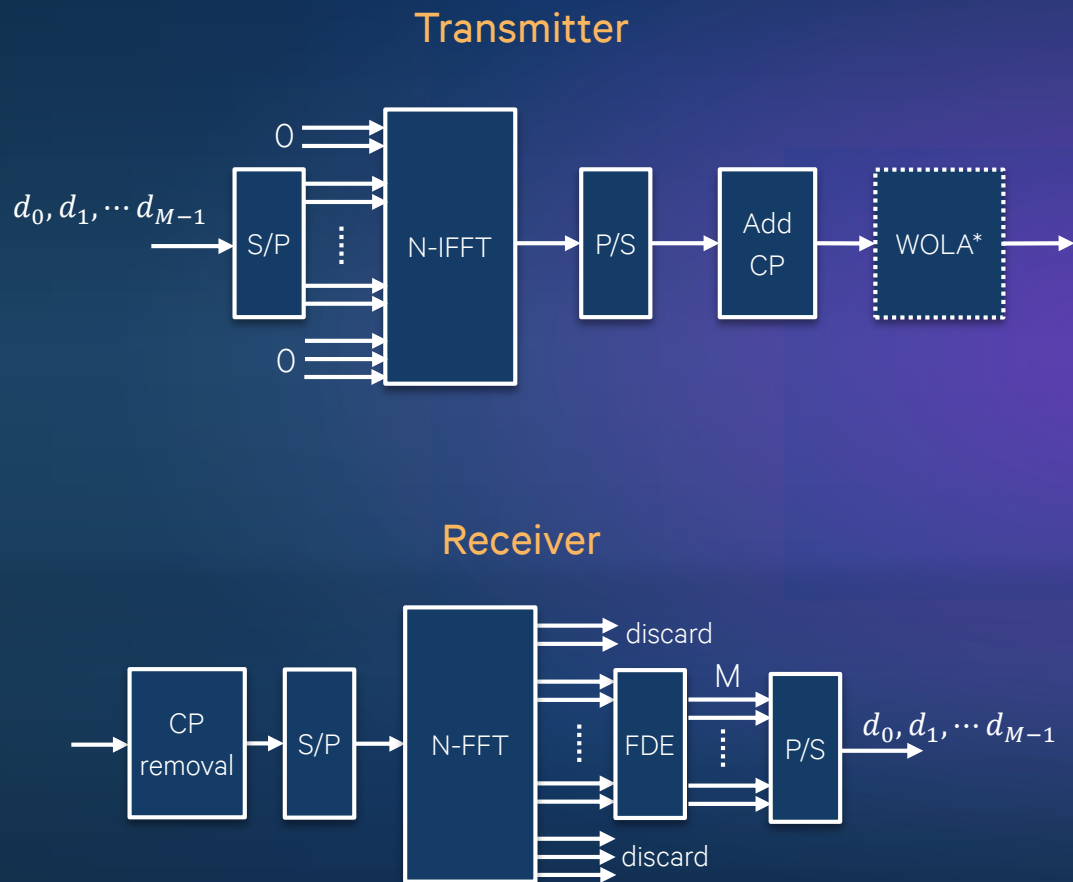

## Key characteristics

- Pros:
  - Efficient implementation using FFT/IFFT
  - Flexible spectrum allocation to different users
  - Straight-forward application of MIMO technology:
    - Flexible signal and data multiplexing, e.g. placement of pilot across the frequency-time grid for channel estimation
    - Simple FDE for multipath interference mitigation
- Cons:
  - Poor frequency localization due to the rectangular prototype filter (without WOLA)
    - Can be significantly improved using WOLA
- Example applications:
  - CP-OFDM with WOLA is used in LTE downlink

\* WOLA is not in LTE spec. but existing implementations typically include WOLA to meet performance requirements

# WOLA substantially improves OOB performance

PSD of CP-OFDM with WOLA at the transmitter

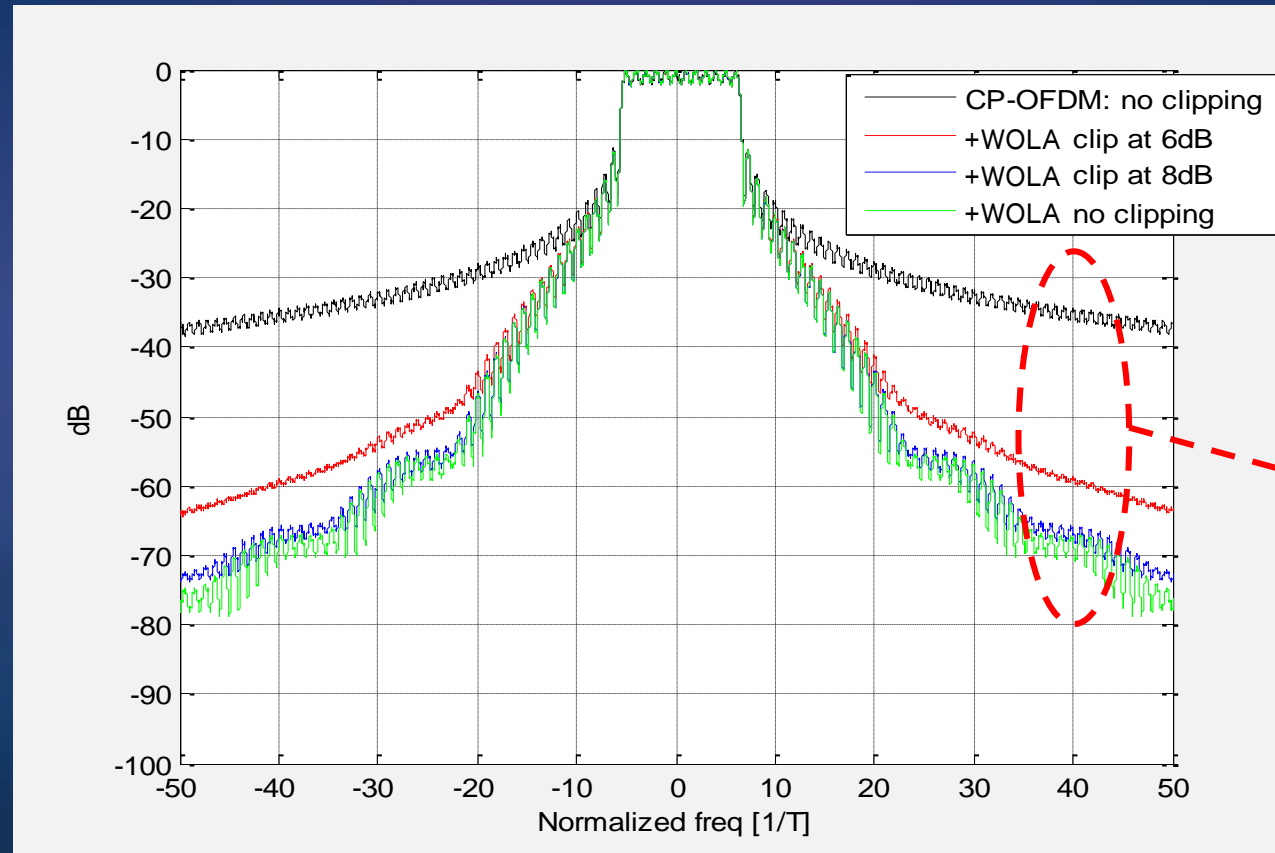

WOLA substantially improves CP-OFDM OOB leakage performance

# Universal-Filtered Multi-Carrier (UFMC)

## Transmitter

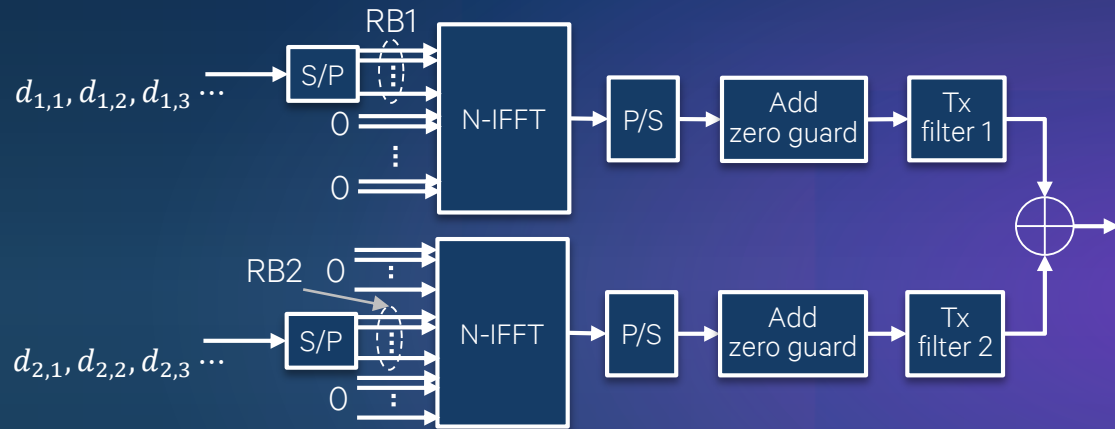

## Receiver

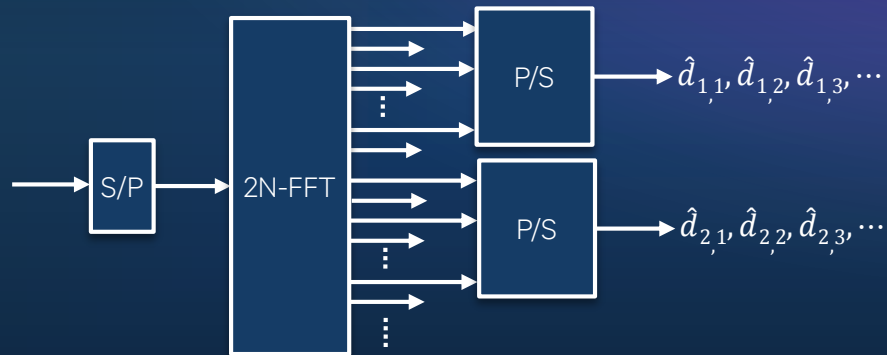

## Key characteristics

- Use band-pass Tx filter to suppress OOB leakage:
  - Each Resource Block (RB) has a corresponding Tx filter, which is designed to only pass the assigned RB
  - A guard interval of zeros is added between successive IFFT symbols to prevent ISI due to Tx filter delay
- Pros:
  - Similar OOB performance as CP-OFDM with WOLA
  - Can be used to multiplex user with different numerologies (similar to CP-OFDM with WOLA)
- Cons:
  - More complex transmitter/receiver design
  - Subject to ISI due to the lack of CP



# Additional details on UFMC transmitter/receiver processing

## UFMC processing at the transmitter

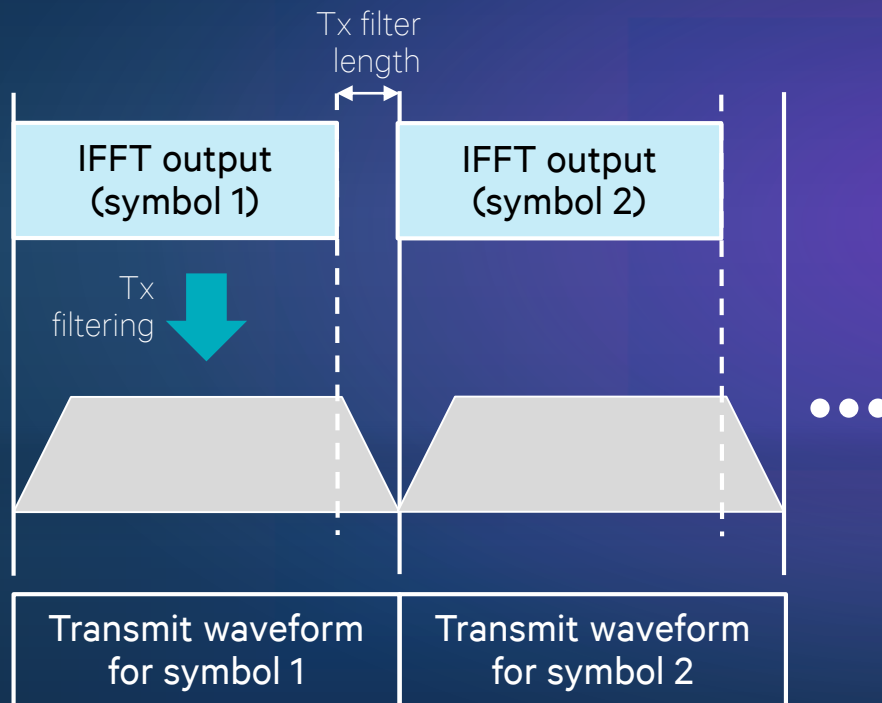

## UFMC processing at the receiver

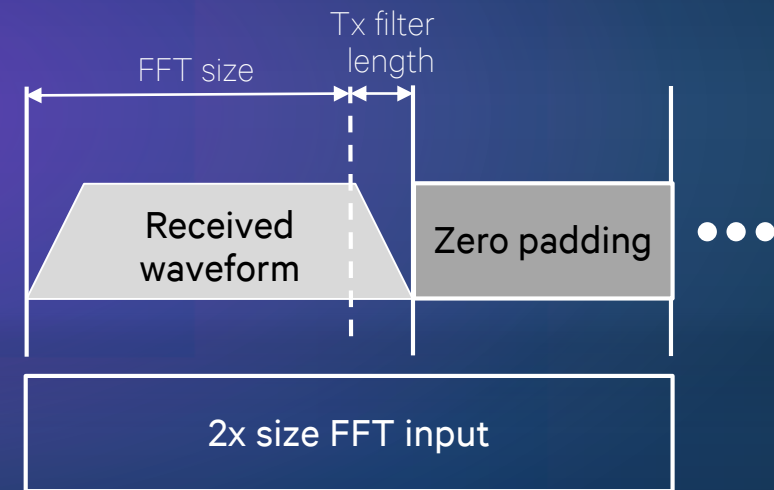

# UFMC has comparable OOB performance as CP-OFDM+WOLA

PSD of UFMC at the transmitter

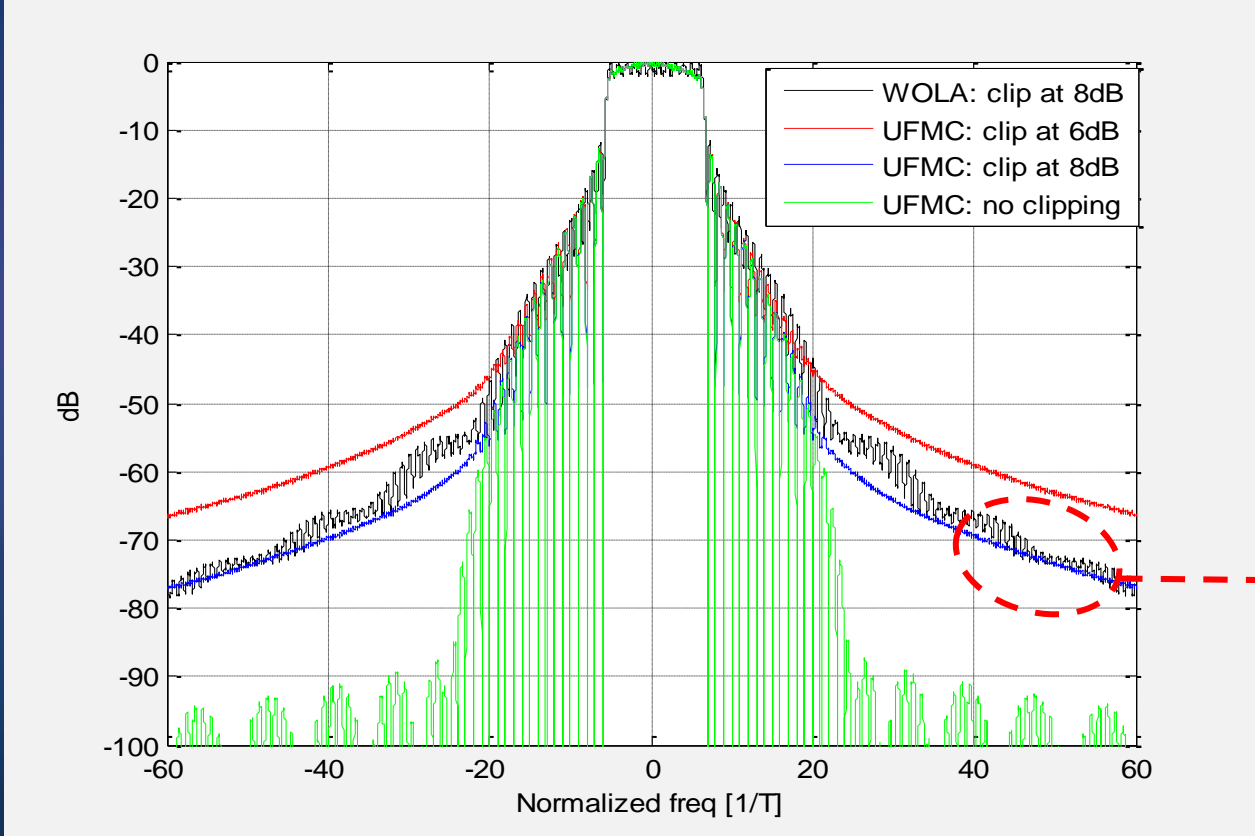

Comparable OOB leakage performance as CP-OFDM+WOLA

Note: WOLA refers to CP-OFDM with WOLA

Assumptions: 12 contiguous data tones, 60 symbols per run, 1000 runs. Chebyshev filter is used for the tx filter. FFT and RB sizes are set to be 1024 and 12 respectively. Chebyshev filter has 102 taps, which corresponds to 10% CP, and has 60 dB of relative side-lobe attenuation

# Filter bank multi-carrier (FBMC)

## FBMC waveform synthesis

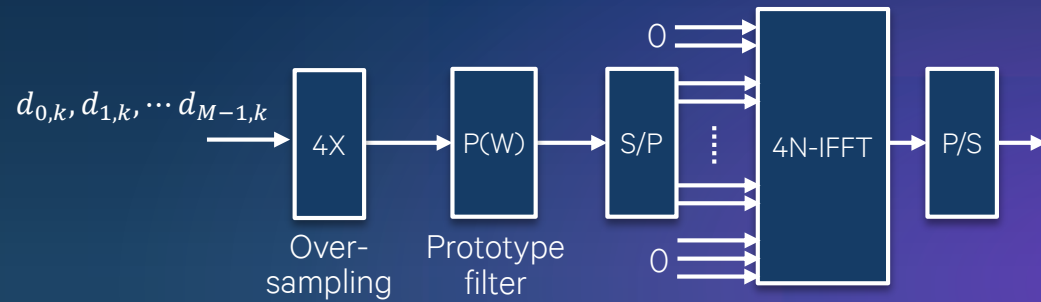

## FBMC/OQAM Transmitter

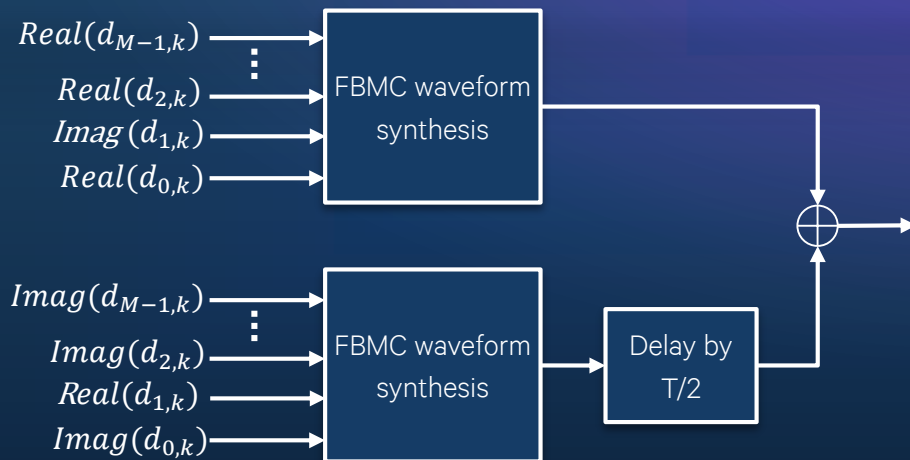

## Key characteristics

- Improve spectral property using prototype filter with frequency domain over-sampling:
  - Prototype filter spans multiple symbol periods,  $T$
  - Adjacent symbols are overlapped & added in time with offset  $T$  to maintain spectral efficiency
  - Overlap-and-add leads to potential ISI and ICI:
    - Use half-Nyquist prototype filter to mitigate ISI
    - Use "Offset-QAM" (OQAM) modulation to remove ICI
- Pros:
  - Superior side-lobe decay than other MC waveforms but the benefit reduces with PA non-linearity
- Cons:
  - Complicated receiver design due to OQAM
  - Subject to ISI under non-flat channel
  - More complex MIMO integration than OFDM

# FBMC prototype filter

Improve spectral property using prototype filter with frequency domain over-sampling

Frequency-domain response with oversampling factor  $K=4$   
(frequency between samples:  $1/4T$ )

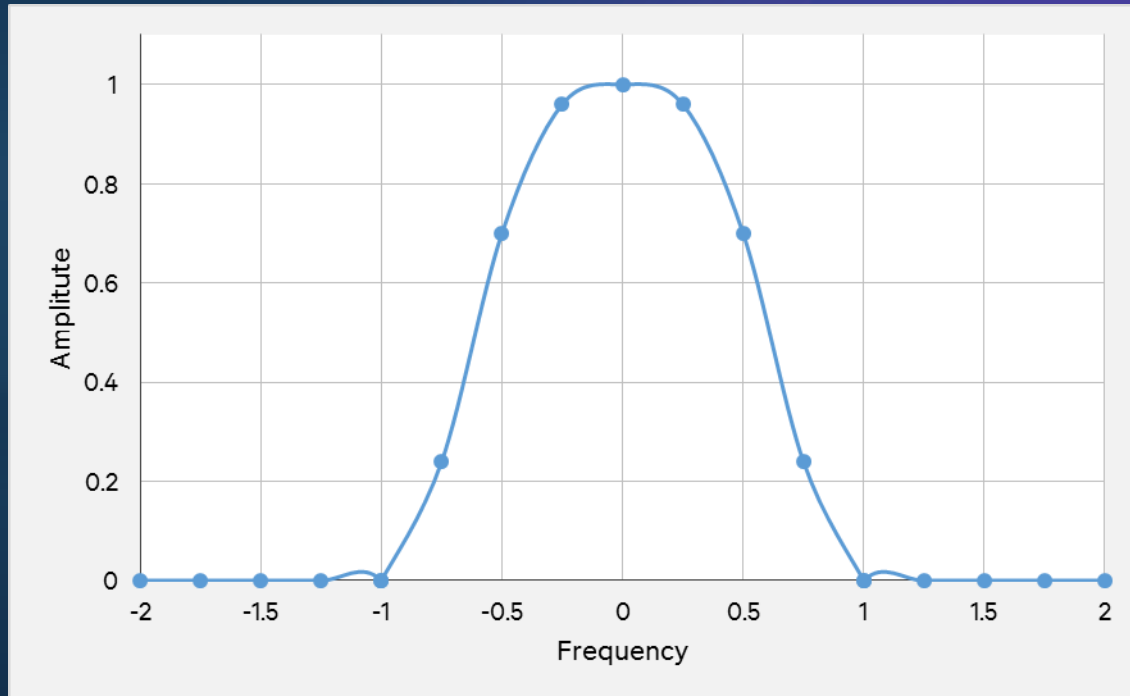

Time-domain response  
(spanning multiple symbol periods  $T$ )

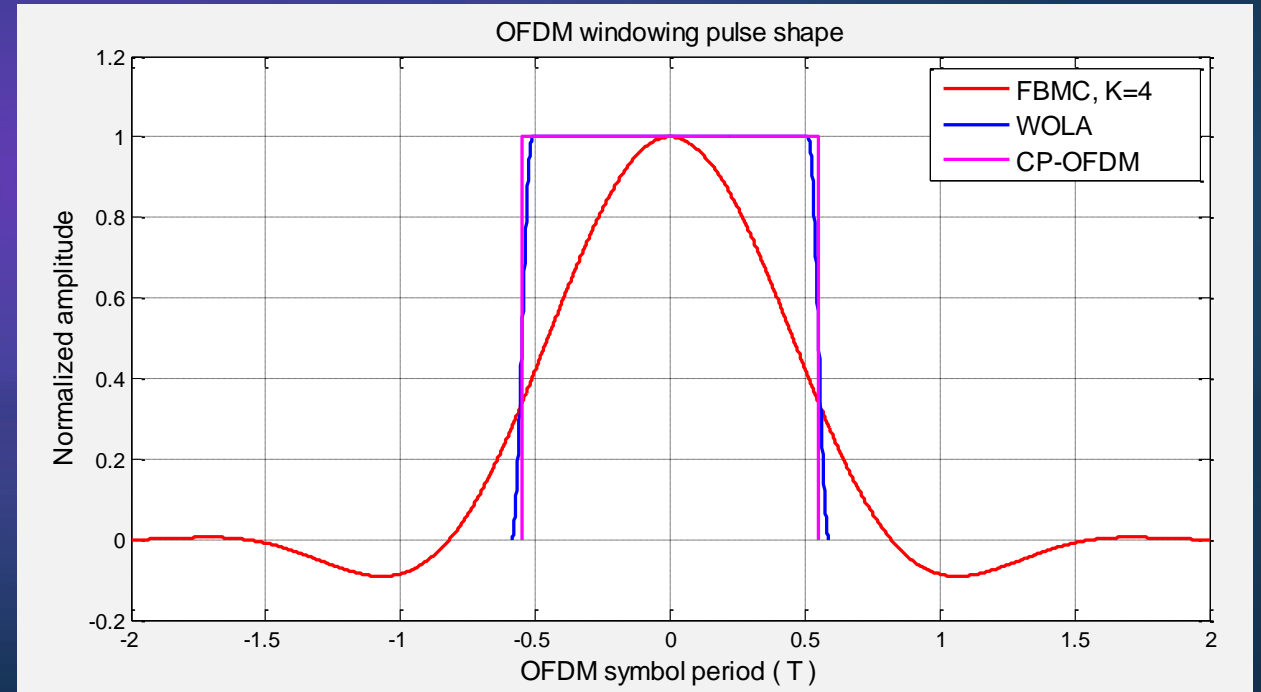

Increased block processing latency can remove the benefits of asynchronous transmission

# FBMC's OOB performance degrades with PA non-linearity

PSD of FBMC at the transmitter

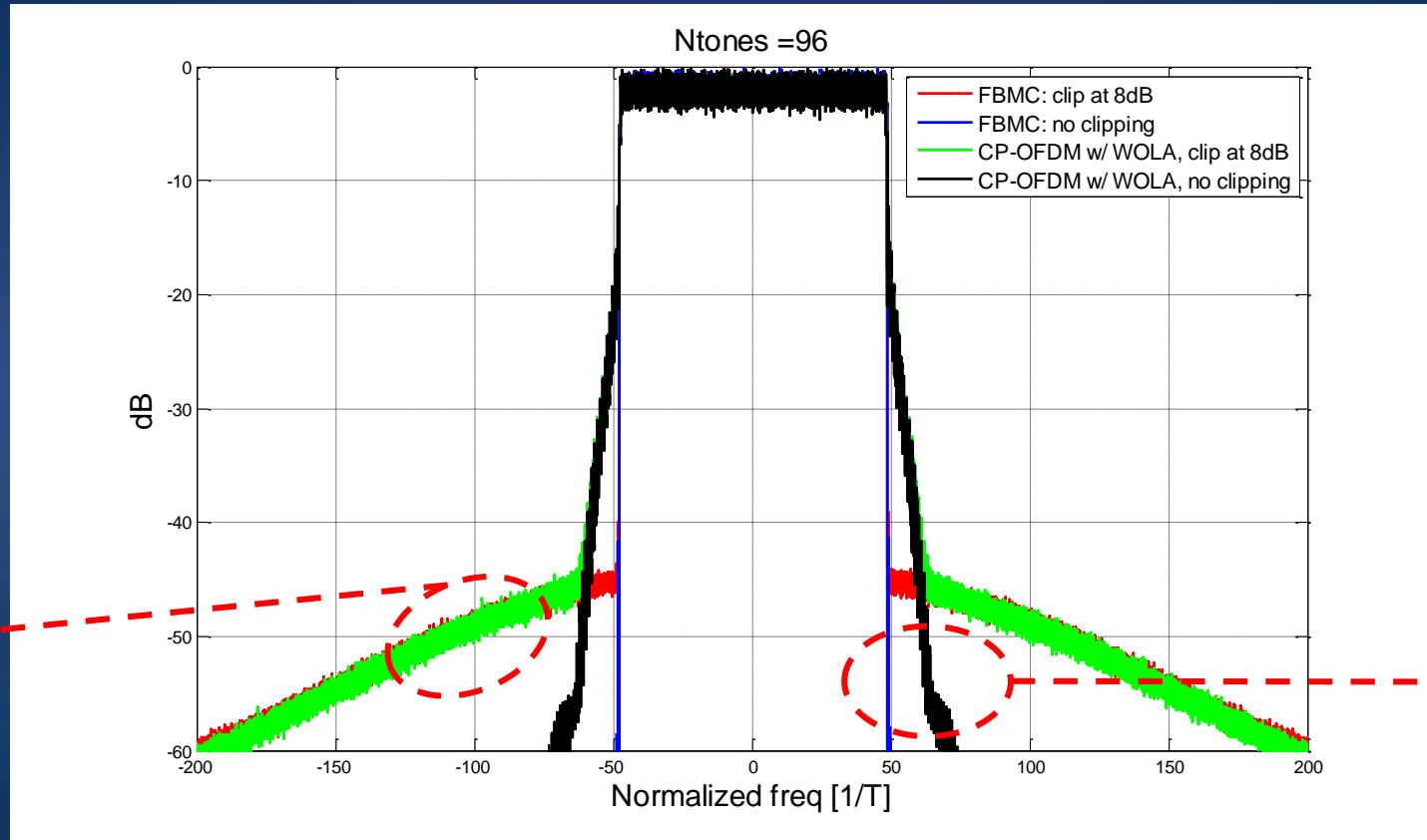

OOB leakage suppression performance reduces with PA clipping

FBMC side-lobe decays faster than CP-OFDM+WOLA with no PA clipping

Downlink transmissions are synchronized and additional improvement in OOB emission performance at the expense of added implementation complexity and less-efficient MIMO support is not preferred

# Generalized frequency division multiplexing (GFDM)

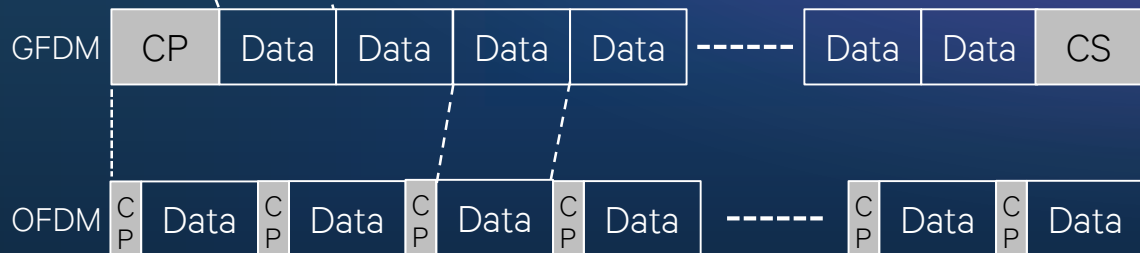
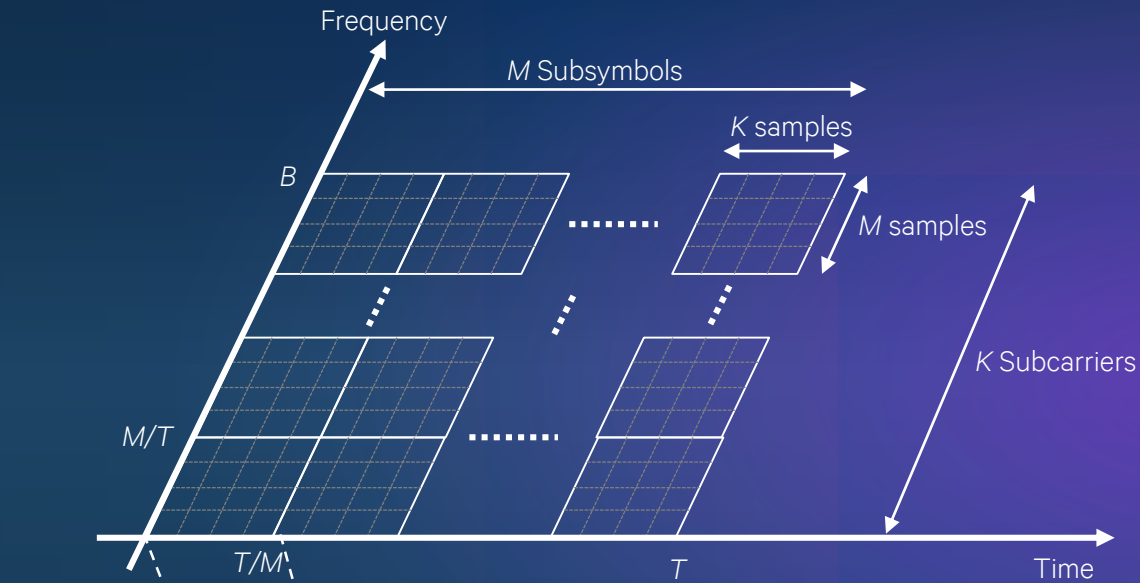

## Key characteristics

- Similar to FBMC where prototype filter is used to suppress OOB leakage. However, for GFDM:
  - Multiple OFDM symbols are grouped into a block, with a CP added to the block
  - Within a block, the prototype filter is “cyclic-shift” in time, for different OFDM symbols
- Pros:
  - Better OOB leakage suppression than CP-OFDM (same as CP-OFDM with WOLA)
- Cons:
  - Complicated receiver to handle ISI/ICI
    - Prototype filter may require more complicated modulation/receiver, e.g. OQAM as in FBMC
  - Higher block processing latency (no pipelining)
  - Multiplexing with CP-OFDM requires large guard band

# GFMD has comparable OOB performance as CP-OFDM

PSD of GFMD at the transmitter

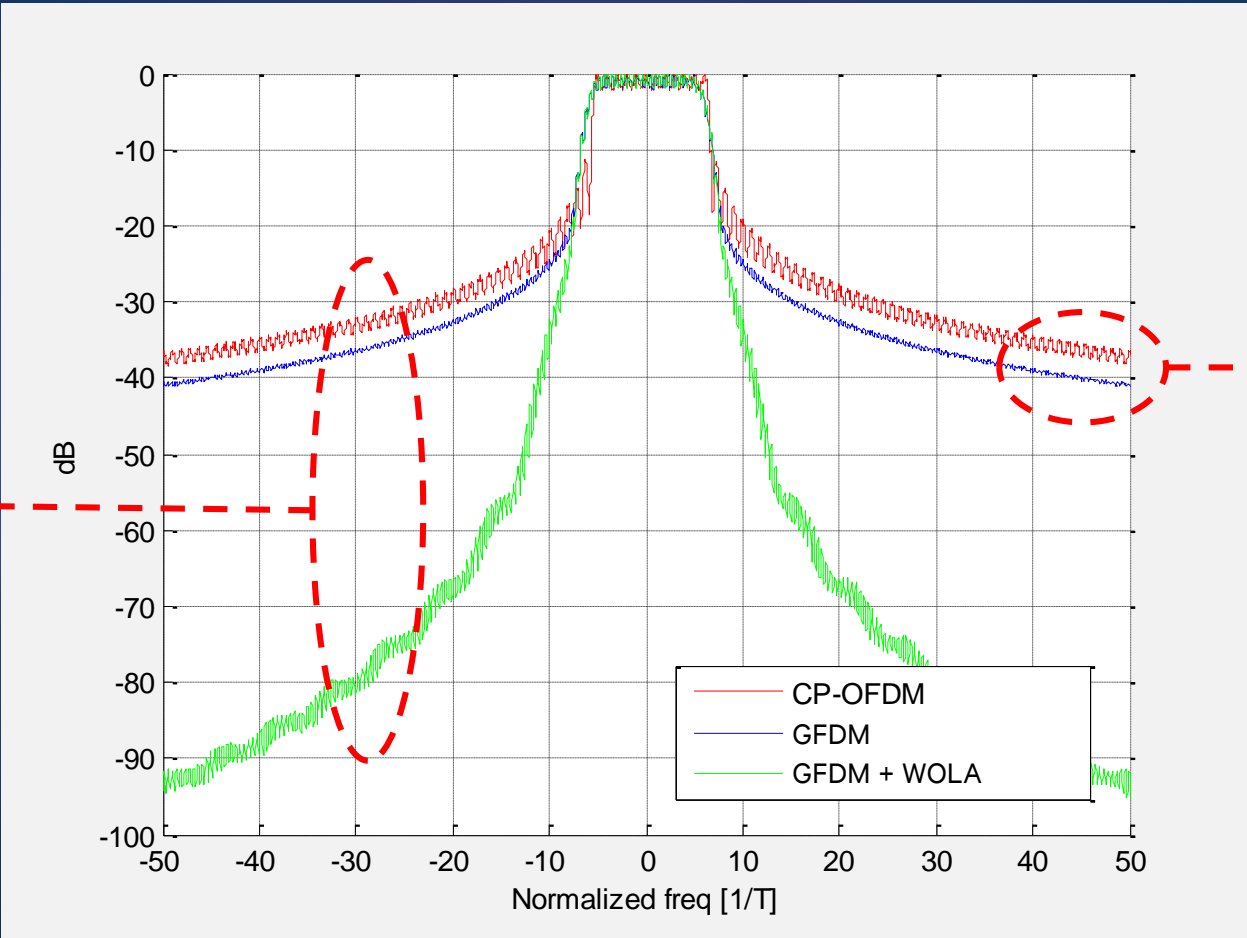

Time-domain windowing (like WOLA) significantly reduces OOB leakage

Comparable OOB leakage performance as legacy CP-OFDM

Assumptions: 3 tones, 9 sub-symbols, 6 symbols per run, 1000runs. CP length is set to be roughly 10% of the OFDM symbol length. For Tx-WOLA, raised-cosine edge with rolloff  $\alpha \approx 0.8$  is used.



# Single-carrier waveform has comparatively lower PAPR

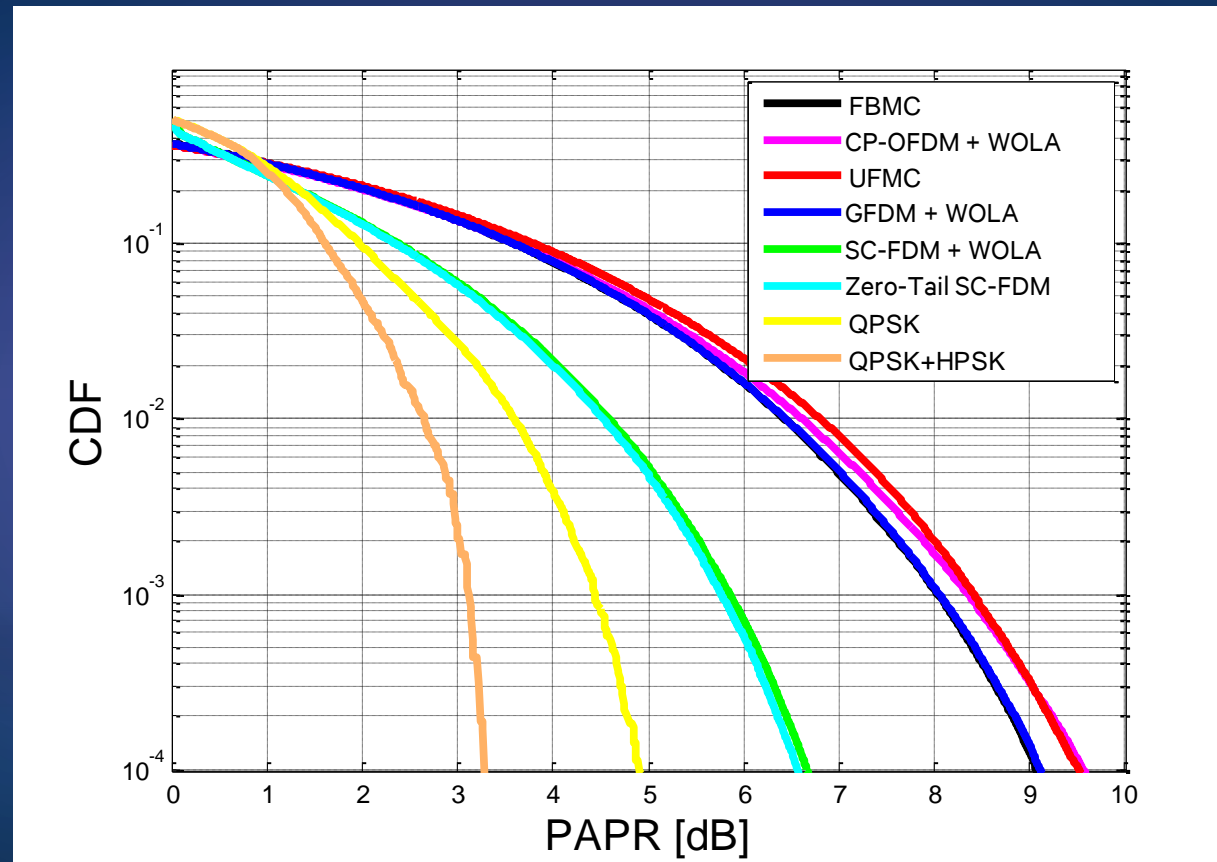

OFDM-based multi-carrier waveform delivers higher spectral efficiency and is suitable for downlink where energy efficiency requirement is more relaxed. Single carrier waveform can be used for other scenarios requiring high energy efficiency.

# Additional information on multiple access techniques



# Potential multiple access schemes

## Orthogonal multiple access

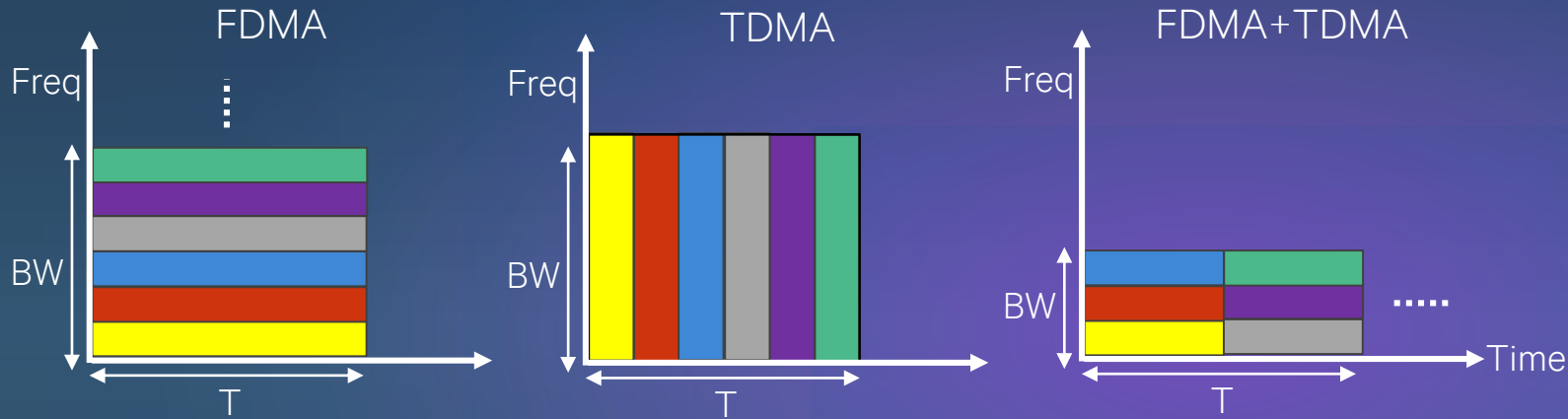

## Non-orthogonal multiple access

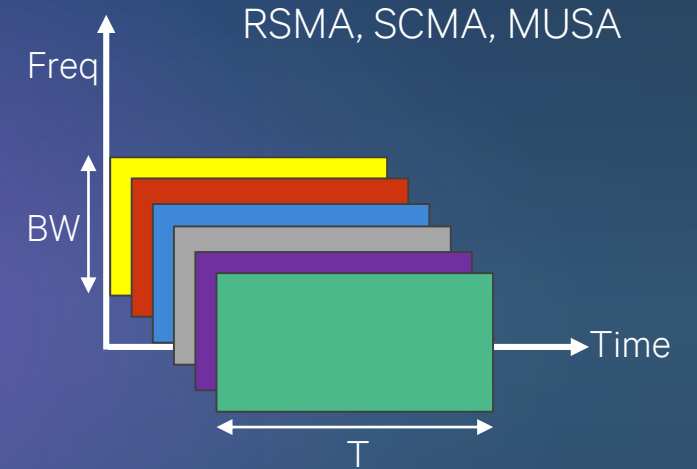

## Example comparison of orthogonal and non-orthogonal multiple access techniques\*

Multiple access techniques:	Non-orthogonal	FDMA	FDMA+TDMA (1RB/user)
Effective Rate (kbps)	50	50	100
EbNo** (dB)	-1.52	-0.73	-0.73
Link budget (dB)	146.1	145.3	142.3

\* Assumptions: 12 users, 500 bits/10ms over 1 MHz bandwidth, 2Rx, an RB = 180kHz. \*\*Derived using Shannon formula.

# Resource Spread Multiple Access (RSMA)

## Single carrier RSMA

Deliver better PA efficiency and has no synchronization requirement

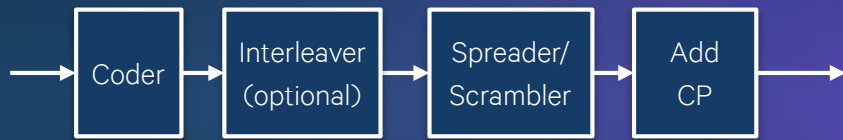

## Multi-carrier RSMA

Exploit wider bandwidth to achieve lower latency for less power-constrained applications

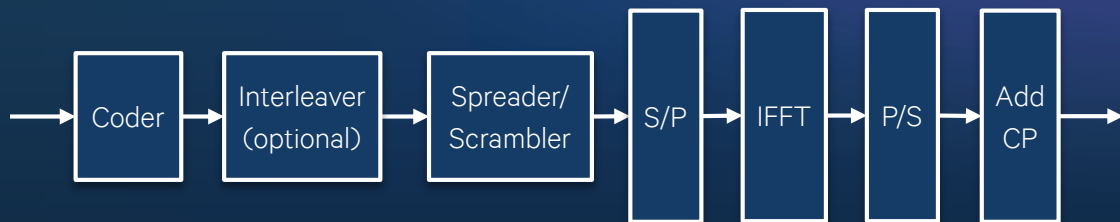

## Key characteristics

- Spread user signal across time and/or frequency resources:
  - Use lower rate channel coding to spread signal across time/frequency to achieve lower spectral efficiency
  - Users' signals can be recovered simultaneously even in the presence of mutual interference
- RSMA is more robust:
  - Coding gain provides  $E_b/N_0$  efficiency compared with orthogonal spreading or simple repetition
  - More powerful codes can be employed than simple repetition combined with low rate convolution codes

# Sparse code multiple access (SCMA)

## LDS-CDMA

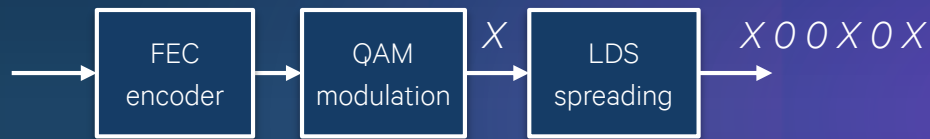

## SCMA



## Key characteristics

- SCMA is based on Low Density Signature (LDS) CDMA
  - Lower-density spreading
  - Only partially uses the available time/frequency resources
- But unlike LDS-CDMA, SCMA uses multi-dimensional constellations:
  - Each user has a unique codebook which maps each of  $M$  codewords to a length  $N$  constellation
  - The length  $N$  constellation is extended to length  $L$  by inserting  $L-N$  zeros.
- Requires iterative multiuser joint detection

# Appendix



# References

1. “5G White Paper”, Next Generation Mobile Networks (NGMN) Alliance, March 2015. Available at <http://ngmn.org/home.html>
2. “Waveform contenders for 5G - OFDM vs. FBMC vs. UFMC”, F. Schaich, T. Wild, *Alcatel-Lucent*, 6th International Symposium on Communications, Control and Signal Processing (ISCCSP), May 2014.
3. “What will 5G be?” J. Andrews, S. Buzzi, W. Choi, S. Hanly, A. Lozano, A. Soong, J. Zhang, *IEEE Journal On Sel. Areas in Comm.*, Vol. 32, No. 6, June 2014.
4. “Power amplifier linearization with digital pre-distortion and crest factor reduction,” R. Sperlich, Y. Park, G. Copeland, and J.S. Kenney, *Microwave Symposium Digest, 2004 IEEE MTT-S International*, Vol. 2, June 2004.
5. “Iterative Precoding of OFDM-MISO with Nonlinear Power Amplifiers”, I. Iofedov, D. Wulich, I. Gutman, *IEEE International Conference on Communications*, June 2015.
6. *Ultra Low Power Transceiver for Wireless Body Area Networks*, J. Masuch and M. Delgado-Restituto, Springer 2013.
7. “Channel coding with multilevel/phase signals,” G. Ungerboeck, *IEEE Transactions on Information Theory*, Vol 28, Issue 1, 1982.
8. “Frequency Domain Equalization for Single-Carrier Broadband Wireless Systems,” D. Falconer, S.L. Ariyavitakul, A. Benyamin-Seeyar, D. Eidson, *IEEE Communications Magazine*, April 2002.
9. “Generalized Frequency Division Multiplexing for 5th Generation Cellular Networks,” N. Michailow, M. Matthé, I.S. Gaspar, A.N. Caldevilla, L.L. Mendes, A. Festag, G. Fettweis, *IEEE Transaction on Communications*, Vol. 62, No. 9, September 2014.
10. “Performance of FBMC Multiple Access for Relaxed Synchronization Cellular Networks”, J.-B. Dore, V. Berg, D. Ktenas, *IEEE Globecom*, 2014
11. “FBMC receiver for multi-user asynchronous transmission on fragmented spectrum”, J.-B. Dore, V. Berg, N. Cassiau, D. Ktenas”, *EURASIP Journal on Advances in Signal Processing*, Vol. 41, March 2014
12. X. Wang, T. Wild, F. Schaich, A. Santos, *Alcatel-Lucent*, “Universal Filtered Multi-Carrier with Leakage-Based Filter Optimization”, *European Wireless 2014*.
13. J. G. Proakis, M. Salehi, *Communication Systems Engineering*, Prentice Hall, Inc. Upper Saddle River, New Jersey
14. D. A. Guimaraes, “Contributions to the understanding of the MSK Modulation”, *REVISTA Telecommunications*, vol. 11, no. 01, MAIO DE 2008
15. K. Murota, K. Hirade, “GMSK Modulation for digital mobile radio telephony”, *IEEE Trans. Comm.* Vol. COM-29, No. 7, July 1981.
16. “IEEE standard for local and metropolitan area networks – Part 15.4: low-rate wireless personal area networks (LR-WPANs)”, *IEEE computer society*.
17. P. A. Laurent, “Extract and approximate construction of digital phase modulations by superposition of amplitude modulated pulses (AMP)”, *IEEE Trans. Comm.*, vol. COM-34, pp. 150-160, 1986.
18. P. Jung, “Laurent’s representation of binary digital continuous phase modulated signals with modulation index  $\frac{1}{2}$  revisited”, *IEEE Trans. Comm.*, vol. 42, no. 2-4, pp. 221-224, 1994.
19. F. Khan, “*LTE for 4G Mobile Broadband: Air Interface Technologies and Performance*”, Cambridge University Press, 2009.
20. G Berardinelli, F. M. L. Tavares, T. B. Sorensen, P. Mogensen, K. Pajukoski, Aalborg University/Nokia, “Zero-tail DFT-spread-OFDM Signals”, *IEEE Globecom 2013*.



# References

21. R. W. Chang, "High-speed multichannel data transmission with bandlimited orthogonal signals", Bell Sys. Tech. J., vol. 45, pp. 1775-1796, Dec. 1966.
22. B. R. Saltzberg, "Performance of an efficient parallel data transmission system", IEEE Trans. Comm. Tech. vol. 15, no. 6, pp. 805-811, Dec. 1967.
23. B. Farhang-Boroujeny, "OFDM versus filter bank multicarrier: development of broadband communication systems", IEEE Signal Proc. Magazine, pp. 92-112, May 2011.
24. M. Bellenger, "FBMC physical layer: a primer", Phydys report, 2010
25. J. Fang, Z. You, J. Li, R. Yang, I.T. Lu, "Comparisons of filter bank multicarrier systems", System, Applications and Technology Conference, IEEE long island, May 2013, pp. 1-6.
26. M. Najar, C. Bader, F. Rubio, E. Kofidis, M. Tanda, J. Louveaux, M. Renfors, D. L. Ruyet, "MIMO channel matrix estimation and tracking", PHYDYAS deliverables D4.1, Jan. 2009.
27. L. Ping, L. Liu, K.Y. Wu, W.K. Leung, "Interleave division multiple-access", IEEE Trans. Wireless Comm., vol. 5, no. 4, pp. 938-947, Apr. 2006.
28. J. Soriaga, J. Hou, J. Smee, "Network performance of the EV-DO CDMA reverse link with interference cancellation", IEEE Globecom 2006.
29. Y. Jou, R. Attar, C. Lott, J. Ma, R. Gowaikar, "CDMA and SC-FDMA reverse link comparison for cellular voice and data communications", IEEE VTC 2010.
30. R. Hoshyar, F.P. Wathan, R. Tafazolli, "Novel Low-Density Signature for Synchronous CDMA Systems Over AWGN Channel", IEEE Trans. on Signal Processing, vol. 56, No. 4, pp. 1616 - 1626, April 2008
31. K. Au, et al. "Uplink contention based SCMA for 5G radio access", IEEE Globecom 2014 (Workshop on Emerging Technologies for 5G Wireless Cellular Networks), December 8-12, Austin, TX, USA
32. M. Taherzadeh, H. Nikopour, A. Bayesteh, H. Baligh, "SCMA Codebook Design", IEEE Vehicular Technology Conference, Sept. 2014
33. "[White Paper on 5G Concept](#)", IMT-2020 (5G) Promotion Group Release Ceremony, Feb. 2015
34. "How to Improve OFDM-like Data Estimation by Using Weighted Overlapping", C.V. Sinn, 11<sup>th</sup> International OFDM Workshop, 2006.
35. P. J. Black, Q. Wu, "Link Budget of cdma2000 1xEV-DO Wireless Internet Access System", IEEE International Conference on Communications 2002.
36. "[5G Design Across Services](#)", Johannesberg Summit, Stockholm, May 2015.
37. A. El Gamal, Y. Kim, "Network Information Theory", Cambridge University Press, 2011.

# List of Abbreviations

Abbreviation	Definition	Abbreviation	Definition
ACLR	Adjacent Channel Leakage Ratio	mmWave	Millimeter Wave
CDMA	Code Division Multiple Access	MSK	Minimum Shift Keying
CP	Cyclic prefix	MUSA	Multi-User Shared Access
CP-OFDM	OFDM with Cyclic Prefix	MU-MIMO	Multiuser MIMO
D2D	Device-to-Device Communication	OFDM	Orthogonal Frequency Division Multiplexing
DFT	Discrete Fourier Transform	OFDMA	Orthogonal Frequency Division Multiple Access
DL	Downlink	OOB	Out of Band Emissions
eMBB	Enhanced Mobile Broadband	OQAM	Offset-QAM
EVDO	Evolution-Data Optimized	PA	Power Amplifier
FBMC	Filter Bank Multi-Carrier	PAPR	Peak-to-Average Power Ratio
FDE	Frequency Domain Equalization	PHY	Physical Layer
FDM	Frequency Division Multiplexing	P/S	Parallel-to-Serial
FDMA	Frequency Division Multiple Access	PSD	Power Spectral Density
FEC	Forward Error Correction	QAM	Quadrature Amplitude Modulation
FFT	Fast Fourier Transform	RB	Radio Block
GFDM	Generalized Frequency Division Multiplexing	RSMA	Resource Spread Multiple Access
GMSK	Gaussian Minimum Shift Keying	RX	Receiver
GSM	Global System for Mobile Communications	SC-DFT-Spread OFDM	Single Carrier Discrete Fourier Transform Spread OFDM
HARQ	Hybrid Automatic Repeat Request	SC-FDE	Single Carrier Frequency Domain Equalization
IAB	Integrated Access and Backhaul	SC-FDM	Single Carrier Frequency Division Multiplexing
IFFT	Inverse Fast Fourier Transform	SCMA	Sparse Code Multiple Access
IoT	Internet of Things	S/P	Serial-to-Parallel
LE	Low Energy	SRS	Sounding Reference Signal
ICI	Inter Carrier Interference	TDD	Time Division Duplexing
ISI	Inter Symbol Interference	TDMA	Time Division Multiple Access
LDS-CDMA	Low Density Signature CDMA	TX	Transmitter
LTE	Long Term Evolution	UFMC	Universal Filter Multi-Carrier
MAC	Multiple Access Control Layer	UL	Uplink
MC	Multi-Carrier	UMTS	Universal Mobile Telecommunications System
MIMO	Multiple-Input Multiple-Output	WOLA	Weighted Overlap and Add filtering
		ZT-SC-DFT-Spread OFDM	Zero-Tail Single Carrier DFT Spread OFDM



# Thank you

Follow us on:  

For more information on Qualcomm, visit us at:  
[www.qualcomm.com](http://www.qualcomm.com) & [www.qualcomm.com/blog](http://www.qualcomm.com/blog)

©2013-2015 Qualcomm Technologies, Inc. and/or its affiliated companies. All Rights Reserved.

Qualcomm is a trademark of Qualcomm Incorporated, registered in the United States and other countries. Why Wait, Snapdragon, VIVE and MuLTEfire are trademarks of Qualcomm Incorporated. Other product and brand names may be trademarks or registered trademarks of their respective owners.

References in this presentation to “Qualcomm” may mean Qualcomm Incorporated, Qualcomm Technologies, Inc., and/or other subsidiaries or business units within the Qualcomm corporate structure, as applicable.

Qualcomm Incorporated includes Qualcomm’s licensing business, QTL, and the vast majority of its patent portfolio. Qualcomm Technologies, Inc., a wholly-owned subsidiary of Qualcomm Incorporated, operates, along with its subsidiaries, substantially all of Qualcomm’s engineering, research and development functions, and substantially all of its product and services businesses, including its semiconductor business, QCT.

